



**CRYSTAL
INSTRUMENTS**

VIBRATION CONTROL SYSTEMS

WWW.CRYSTALINSTRUMENTS.COM



**KVALITEST
INDUSTRIAL**

Vibration Control Systems - Hardware Platforms

Spider-81

The Spider-81 is the flagship model of Crystal Instruments vibration controllers. This 4th generation hardware is highly modular, distributed and scalable. Each Spider-81 has 8 analog input and 4 analog output channels. Eight digital I/O pairs are provided for custom applications. A bright front panel LCD displays the system status and test information. Users can instantly view real-time status information such as control RMS or sweeping frequency on the LCD panel.



Spider-81 Premium Vibration Controller

The Spider-81 not only uses Ethernet for data communication, it goes further by employing IEEE 1588v2 time-synchronized Ethernet connectivity. This technology allows (up to 100 meters in distance) remote input modules to be connected solely by Ethernet (with no dedicated “sync” cable required), while still provides sampling and triggering synchronization within an accuracy of 50 ns. The Spider-HUB industrial Ethernet switch can expand the Spider-81 controller up to 512 input channels. All input channels across the system are amplitude matched within 0.1 dB and phase matched within 1° over a 20 kHz bandwidth.

All Spider front-ends contain a 4 GB flash memory for the storage of data and test processing instructions. If longer recording is required, the Spider-NAS (Network Attached Storage) provides at least 250 GB of solid-state disk (SSD) storage in a removable SATA cartridge. One Spider-NAS records streamed time waveforms for up to eight Spider front-ends at the same speed of 102.4 kHz per channel.



Spider-81B Basic Vibration Controller

Spider-81B Economical Vibration Controller

The Spider-81B front-end is a smaller, simplified system providing everything needed to run Sine, Random or Shock tests, measuring the control, and up to 3 monitor signals. This basic system offers a very comprehensive facility with the same control quality, safety assurance, measurement precision, expandability and human interface that distinguishes all Crystal Instruments controllers.



Shown here are the Spider-80XA35, the Spider-HUB, the Spider-NAS, and 9 Spider-80X front-ends.



The Spider-80X is designed for vibration control, machine monitoring, and data acquisition.



The Spider-80Xi is a compact, lightweight, high channel count data acquisition system intended for portable field use.



The Spider-80M is dedicated to MIMO control and MIMO structural testing applications.

Spider-80X

The Spider-80X is a compact package designed for applications in three fields: dynamic data acquisition, vibration control, and machine monitoring. It features eight analog input channels and two channels that can be software selected as analog outputs for vibration control or tachometer inputs for the analysis of rotating machinery.

Spider-80Xi

The Spider-80Xi is a platform that can host various front-end cards. Featuring a 64-channel chassis weighing less than 10.5 kg, the Spider-80Xi can be carried in one hand and is optimal for field environmental testing where portability is essential.





The Spider-80Xi system consisting of the 64-channel chassis is powered by AC power at 100 to 240 VAC. The Spider-80Xi system consisting of the 32-channel chassis is powered by DC power at 10V to 22V. The latter is easily operable with the Spider-Battery (an external battery pack developed by Crystal Instruments) for acquiring data up to 4 hours without interruption.

Spider-80Xi platforms can host various front-ends including voltage, IEPE, strain, temperature or charge mode. Multiple Spider-80Xi chassis can combine to create a system with up to 512 channels, all simultaneously sampled and synchronized in excellent phase match between all channels, either on the same front-end or across front-ends, or even across multiple chassis.

Spider-80M

The Spider-80M platform is based on the efficient Spider-80Xi architecture and is dedicated to MIMO VCS control and MIMO structural testing applications. Each Spider-80M chassis features 8 outputs capable of carrying out 6-degree of freedom MIMO testing. One Spider-80M chassis and multiple Spider-80Xi chassis can chain together to form a very large system with up to 504 input channels.

Hardware Platform	Spider-81	Spider-81B	Spider-80X	Spider-80Xi	Spider-80M
Application	VCS, DSA*	VCS, DSA*	VCS, DSA, EMA*	VCS, DSA, EMA*	MIMO VCS, MIMO FRF*
Number of Front-ends Per Chassis	1	1	1	8	7
Number of Inputs per Front-end	8	4	8	8	8
Max Number of Inputs Per Chassis	8	4	8	64	56
Channel Expansion Via Slave Chassis	Yes	No	Yes	Yes	Yes
Max Number of Chassis Per System	64	1	64	8	8
Max Number of Front-ends Per System	64	1	64	64	63
Max Number of Inputs Per System	512	4	512	512	504
Number of Outputs Per System	4	1	2	2	8
Input Mode	Charge TEDS IEPE Voltage	Charge TEDS IEPE Voltage	Charge (optional) TEDS IEPE Voltage	Charge TEDS IEPE Voltage Strain gage MEMS RTD Thermocouple	Charge TEDS IEPE Voltage Strain gage MEMS RTD Thermocouple
Digital I/O	8 in/out, isolated	4 in/out, isolated	4 in/out, isolated	4 in/out, isolated	4 in/out, isolated
Front Panel LCD	Yes	No	No	Yes	Yes
Front Panel Start/Stop button	Yes	Yes	Yes	Yes	Yes
High Speed Data Port	Yes	No	Yes	Yes	Yes
Notes	Flagship product for VCS line. Input protection up to 250V. Equipped with Stop/ Start button.	Economical solution	Modular at box level.	Modular at board level. Input Mode depends on front-end type. See the following table.	Modular at board level. Input Mode depends on front-end type. See the following table.

-  * VCS = Vibration Control System
-  * DSA = Dynamic Signal Analyzer
-  * EMA = Experimental Modal Analysis
-  * MIMO VCS = Multi-input Multi-output Vibration Control System
-  * MIMO FRF = Multi-input Multi-output FRF analysis in EMA





The Front-ends of the Spider-80Xi and Spider-80M Platform

Front-end Types	Spider-80Xi	Spider-80SGi	Spider-80Ti
Max Sampling Rate	102.4 kHz	102.4 kHz	2 kHz
Number of Inputs Per Front-end	8	8	16
Connector Type	BNC	LEMO	3-pin screwed terminal
Input Type	IEPE Voltage TEDS	Voltage Strain gage Strain gage-based sensors MEMS DC-based sensors	3-wire RTD K type thermocouple
Input Coupling	AC Differential DC Differential AC Single-ended DC Single-ended	AC Differential DC Differential	-----
Sensor Excitation	4.2 mA at 21 V for IEPE	2.5V, 5V, 10V	-----
Strain Gage Type	-----	Quarter Bridge Type I, II Half Bridge Type I, II Full Bridge Type I, II Excitation voltage: $\pm 2.5, \pm 5$	-----
Max Input Range	$\pm 20V_{pk}$	$\pm 10V$	-----
Input Protection Voltage	$\pm 220V$	$\pm 40V$	-----
Analog to Digital Converter Per Channel	Dual 24-bit ADC	24-bit ADC	-----
Cross Talk	< -100 dB	< -130 dB	-----
Amplitude Accuracy	$\pm 0.1\%$ at 1kHz 1V	$\pm 0.1\%$	-----
Phase Match	< 1° up to 20kHz	< 1° up to 20kHz	-----

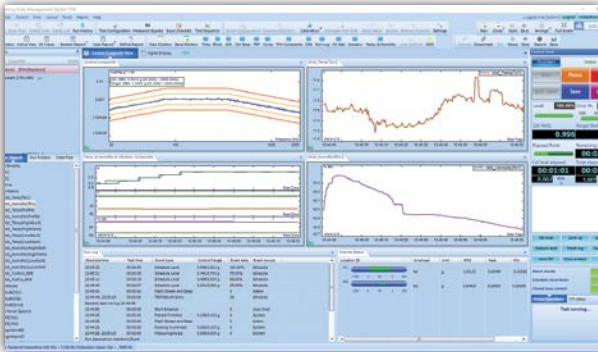

Temperature and Humidity Chamber with a shaker system

Combined Environmental Testing

The industry trend demands environmental testing conducted in fully integrated environments. Various physical parameters, including vibration (acceleration, velocity and displacement), temperature, humidity, pressure, torque, and electrical signals such as those from CAN-bus should be monitored and controlled by one system. Crystal Instruments made dedicated efforts to achieve this goal.

Using the Ethernet network and PTP time synchronization technology, all Spider hardware devices connected to the LAN can be accessed and configured as one integrated system.

The Spider-101 is specifically designed to perform tests subjecting the DUT to simultaneous temperature cycling and variable humidity. The Spider-101 controls both temperature and humidity in a chamber system, which includes external heating/cooling and humidification/dehumidification systems.



The Spider-101 Temperature/Humidity Controller

When vibration control is required along with temperature and humidity control, users can access the parameter and schedule setup between all combined physical quantities from one fully integrated user interface. Users can execute vibration tests such as Random, Sine, Shock, SoR, RoR, and other types together with various cycle settings of temperature and humidity.

- One integrated setup
- One clock and schedule
- One user interface
- One testing report
- One vendor to provide technical support



EDC running on a touch screen terminal



Ethernet Connection

Chamber

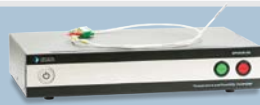

Spider-101 Controller

Temperature Measurement & Control

Humidity Measurement & Control

Software Designed for Combined Environmental Testing

EDC (Embedded Device Controller) and EDM THV are two software modules specifically designed for the Spider-101 to perform Temperature/Humidity (TH) or Temperature, Humidity, and Vibration (THV) control tests.

EDC is a lightweight Windows application with an interface designed for touchscreen use. It runs smoothly on both Intel-based and ARM-based Windows 10 tablets, which can serve as wireless touchscreen terminals that users can mount to the testing chamber. In addition, there is a wide selection of Windows tablets offered in the market that fulfill various requirements (such as the IP6X tablet). The Spider-101 controller runs on EDC software to conduct TH testing (without vibration) in independent climate chambers. Users can configure a test, operate a test, review test logs and review signals from the EDC interface.

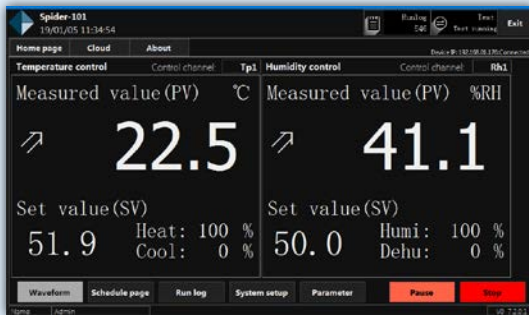

Test status page of EDC on a wireless, touchscreen terminal.

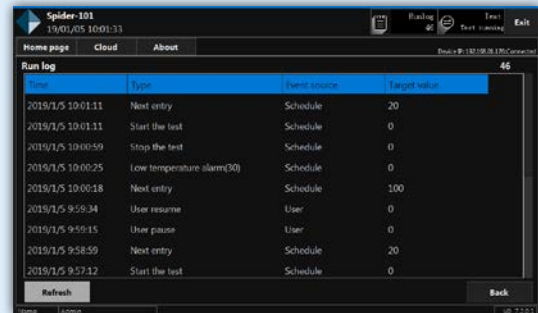

Run log page of EDC on a wireless, touchscreen terminal.

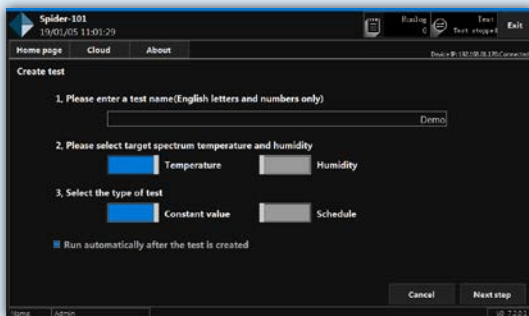

Create test page of EDC on a wireless, touchscreen terminal.

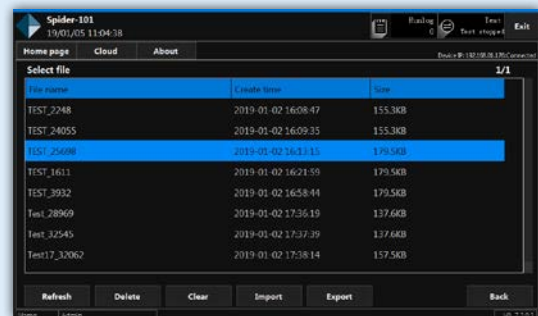

Signal file page of EDC on a wireless, touchscreen terminal.

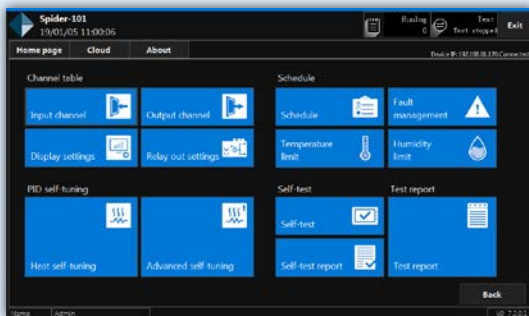

Parameter page of EDC on a wireless, touchscreen terminal.

**MIL-STD-810H
Method 520.5**

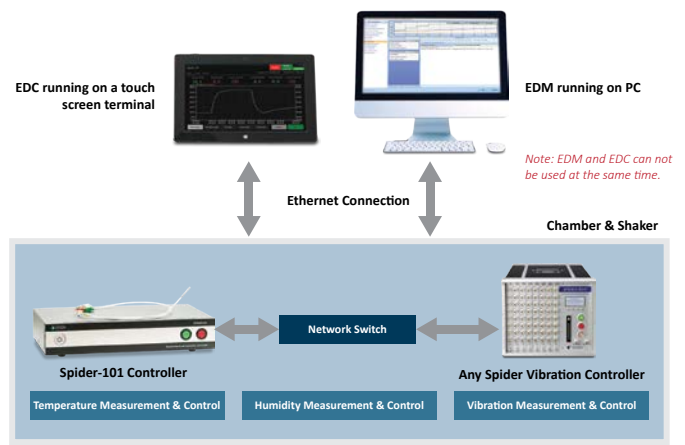
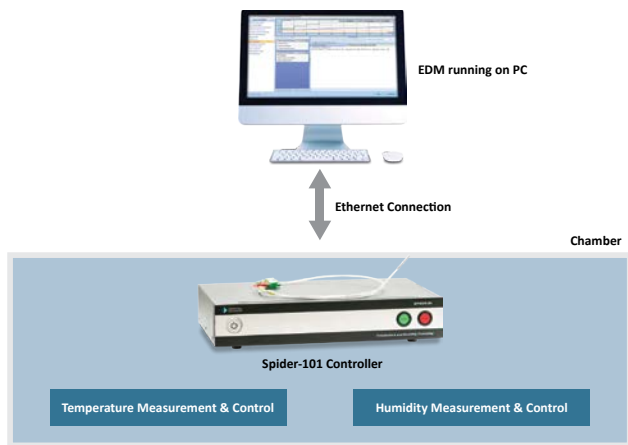
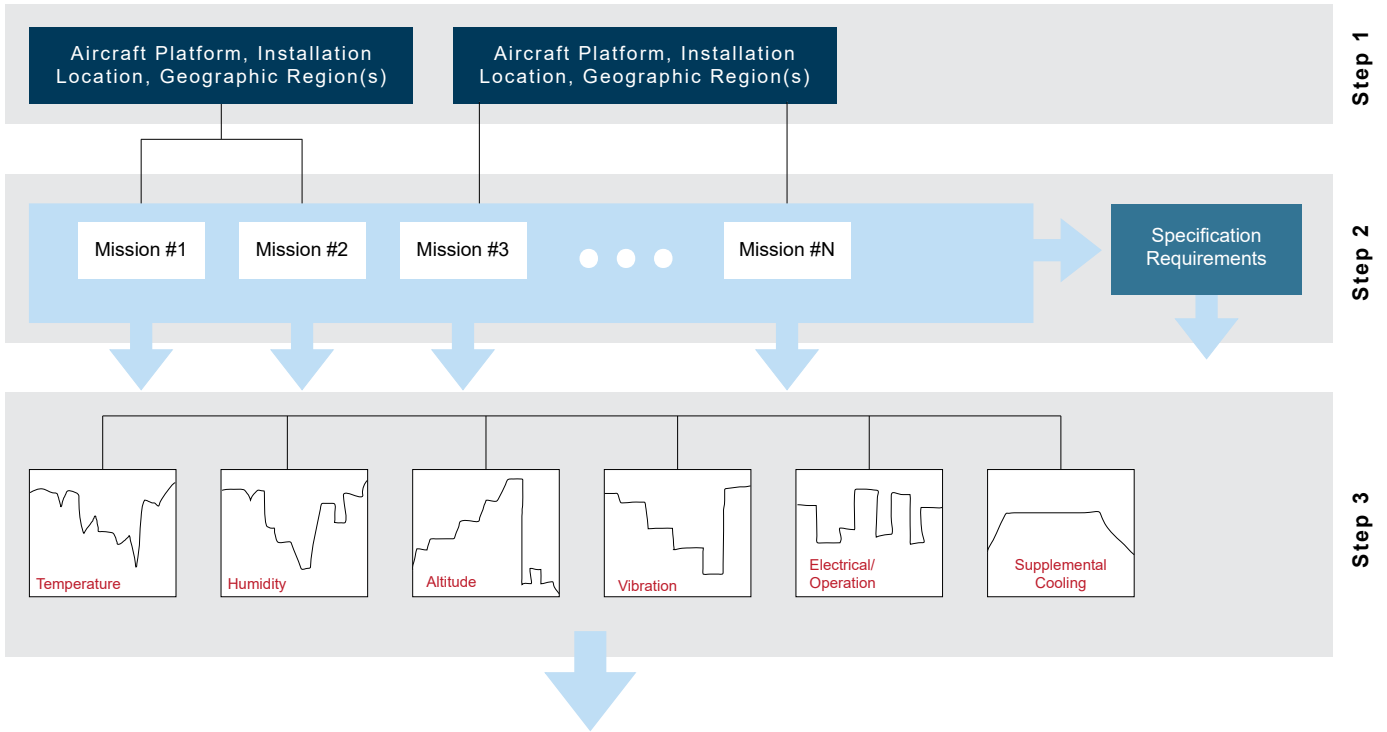

EDM THV is the THV control software application included in EDM (a PC-based software developed by Crystal Instruments). Use EDM THV with Spider-101 when vibration control is required along with temperature and humidity control. EDM THV is a premium and full-featured software product as well as EDM VCS (Vibration Control System) and EDM DSA (Dynamic Signal Analyzer).

EDC and EDM THV can be used together to provide great flexibility and portability to the test operation.

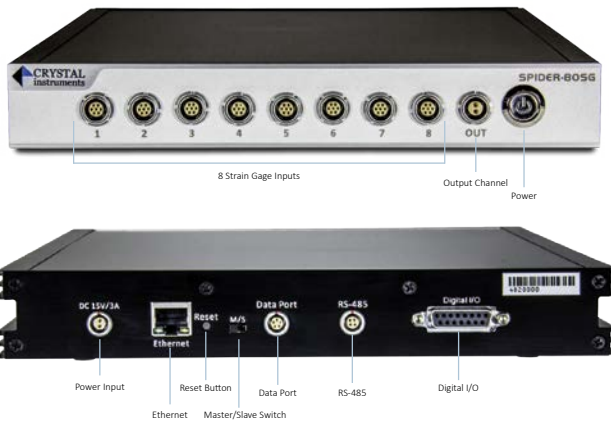
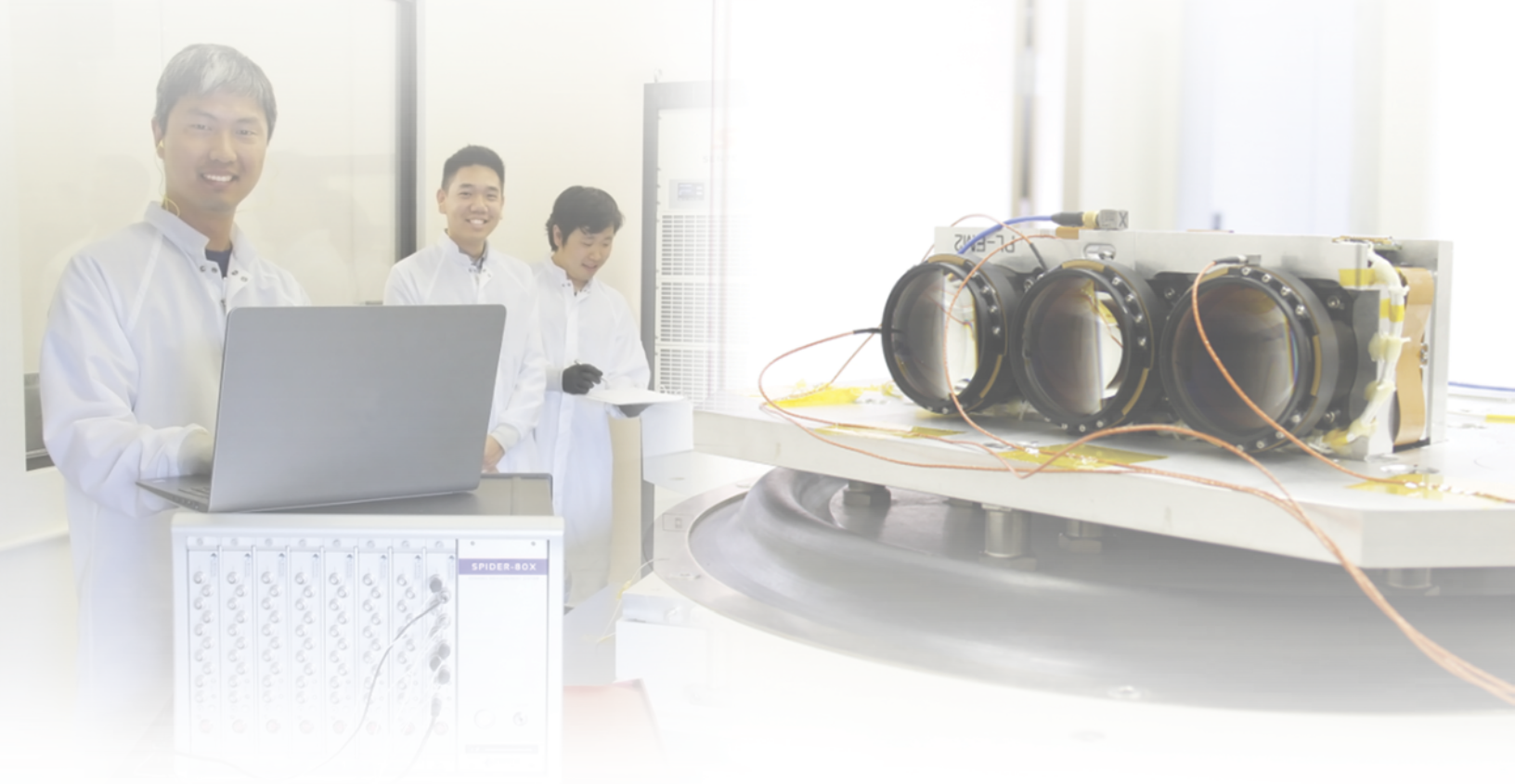

The Spider-80SG Strain Gage Measurement System

Strain Gage Measurement

The Spider-80SG Strain Gage Module

The Spider-80SG/SGi is a front-end in the Spider-80X/Xi hardware family platform. It is a high precision, general purpose data acquisition device featuring strain gage functionality. This device can be used in a variety of physical and measurement tests.

The Spider-80SG can acquire data from a strain gage or a wide range of sensors. With the help of precision excitation voltage, the Spider-80SG/SGi can support strain gage based sensors, MEMS sensors, and DC sensors (to name a few) thus expanding the scope of the Spider-80Xi hardware platform to support the synchronized acquisition of a wide range of measurement quantities including Force, Torque, Pressure, Acceleration, Velocity and Displacement. It can be used for strain measurement and many other types of sensors that requires external power. EDM-DSA and VCS software fully supports the Spider-80SG front-end in all its testing operations.

In addition to the features shared with the Spider-80Xi hardware platform, the Spider-80SG/SGi offers the following capabilities.

High Channel Count

Named for their networkable ability, the Spider hardware platforms (including the Spider-80X/Xi and the Spider-80SG/SGi) share the flexibility of scaling up in channel count and functionality. The Spider-80SG/SGi can combine with any Spider-80Xi device to create a high channel count system with up to 512 channels.

Spider-80SG

Highlighted Features:

- 8 Strain Gage/General Purpose Inputs Per Front-end
- 24-bit ADC Channel
- Supports Multiple Measurement Quantities
- Supports Quarter Bridge, Half Bridge and Full Bridge and Rosette Strain gage Configurations
- Supports a Variety of Strain Gages based sensors, Load Cells, Pressure Transducers, Torque Sensors, MEMS Accelerometers, Displacement Sensors, Velocity Transducers and Geophones
- User Configurable Synchronized Sampling Rate
- Remote sensing: Measures strain accurately from up to 1000 ft cable length with up to 10 KHz frequency.
- Precision Excitation Voltage of $\pm 2.5V$ and $\pm 5V$
- Power Supply Voltage of 2.5V, 5V and 10V for Sensor Excitation
- Shunt Calibration
- Offset Nulling for any measurement quantity
- Multiple Trigger Modes
- Compact, Portable Design
- Scale up to 512 channels using multiple front-ends
- User selectable sampling rate for each front-end in a high channel count system
- DC Drift: less than $1.5 \mu V/V$ in 48 hours

Dual Modes of Excitation

The Spider-80SG is equipped with dual excitation modes. There is an option for Precision Excitation Voltage of $\pm 2.5V$ or $\pm 5V$ that can be used to excite a strain gage or a strain gage based sensor and to accurately measure the minute change in resistance. It is also equipped with a user configurable DC power supply of 2.5V, 5V and 10V which can be used as an excitation voltage for a wide variety of sensors.

Strain Measurement

The Spider-80SG/SGi supports Quarter Bridge, Half Bridge and Full Bridge configurations for each input channel. It also supports measuring strain through Rosette configurations by combining the user selected channels in the desired configuration.

Remote Sensing

The Spider-80SG has been tested to work on strain gages up to 1000 ft away from the analyzer using the remote sensing feature. Using an 18AWG 5 conductor cable to measure the excitation voltage using remote sensing and changes in output voltage, the error was measured to be less than 1.5% for signal frequencies up to 10 KHz.

Measurements Quantities and Sensor Types

The Spider-80SG/SGi's user-selectable precision excitation voltage feature enables it to interact with a wide range of sensors, allowing the synchronized acquisition of a wide range of measurement quantities.

Supported Sensor Types: MEMS based Sensors, Strain gage based sensors, Precision Excitation DC Sensors.

Supported Measurement Quantities: Force, Pressure, Torque, Acceleration, Displacement, Velocity, Sound Pressure.



High Channel Count Solution - Using Spider Front-ends

Spider systems use superior Ethernet and time synchronization technology developed by Crystal Instruments which allows modular expansion to support up to 512 input channels. When a system is running with multiple front-ends totaling to hundreds of input channels, all data is simultaneously acquired and is accurately phase matched. The phase match accuracy can be less than 1 degree within the normal testing frequency range. By providing such high phase match, the frequency response function of cross channel measurement can be used for analyzing the characteristics of the UUT (unit under test), such as modal shape and damping ratio.



Spider-HUB Industrial Ethernet Switch



Spider-NAS Storage Device

In a Swept Sine test that runs hundreds of input channels, the tracking filter and notching can be applied to any of input channels. In a Random control test, the monitoring channel, limiting, or Sine-On-Random can all be simultaneously applied to all input channels. In TTH or Shock, all data captured among all channels will be acquired simultaneously. CI's Spider system is the only product in the world that fully integrates the DSA and VCS functions to operate with up to 512 channels.

Data recording on Spider systems can be realized via either of two approaches: (1) record the time-stream data into the flash memory on each of Spider front-end or (2) record the time-stream data into an external storage device such as the Spider-NAS.

The Spider-NAS can store simultaneous data from all (64 maximum) attached dynamic measurement channels at a sample rate as high as 102.4 kHz, or as low as a few samples per second. If a system has more than 64 channels, every 64 channels will require one Spider-NAS.

Spider-80Xi System (512 Channel Count)

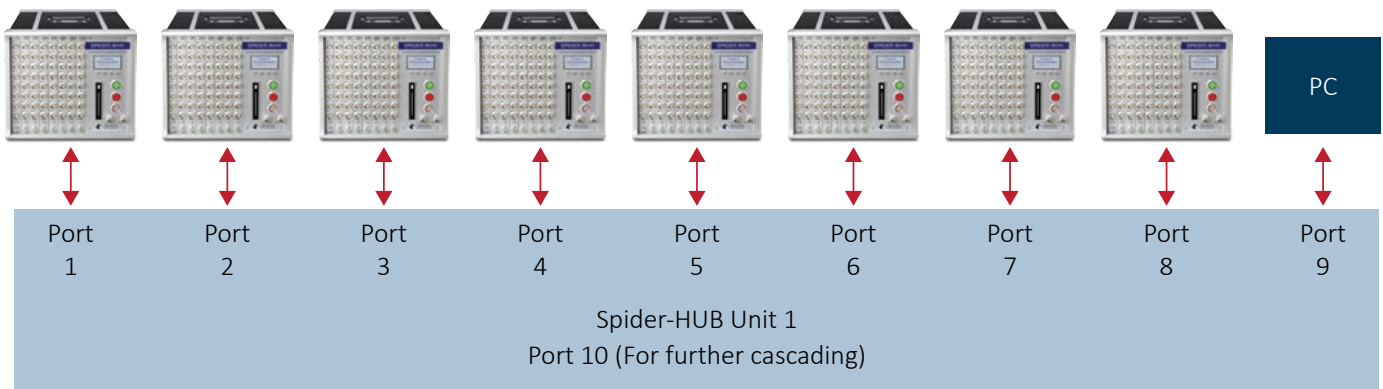

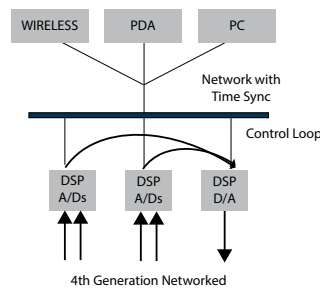
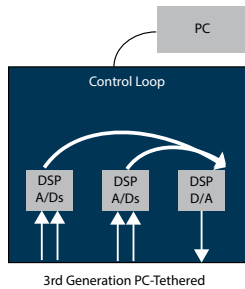
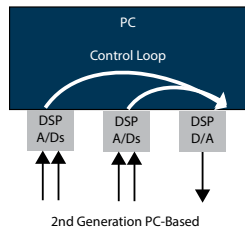
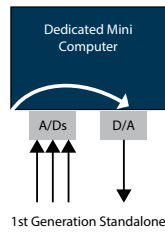

The Spider platform is based on a fourth generation DSP centralized architecture.

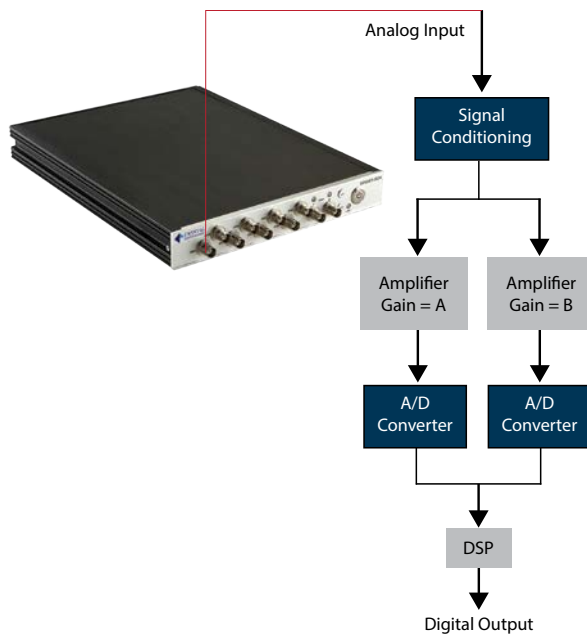

Hardware per US Patent 7,302,354 applies two ADCs to each input channel.

Vibration Control Systems - Unique Features

Latest Hardware Design

The Spider front-ends have voltage, IEPE and charge inputs which are ideal for shock, vibration, and acoustic measurement, strain or general-purpose voltage measurement. The internal flash memory stores test configuration data for controlling up to hundreds of channels simultaneously and stores real-time analysis data. Multiple output channels provide various signal output waveforms that are synchronized with the input sampling rate. Ten monitoring connections on each unit are used to read analog input and output signals. There is a built-in isolated digital I/O to interface with other hardware. Our scalable architecture allows users to employ as many as 512 input channels for the utmost spatial resolution. Sampling to 102.4 kHz provides excellent time resolution while spectra with up to 12,800 lines may be controlled. Data is stored into 4 GB of internal flash memory. Increased storage space is possible with the addition of a 250 GB external unit.

Shaker Compatibility

Spider controllers work with any electrodynamic, servo-hydraulic, or servo-electric shaker with all ranges of force ratings, from tiny desktop to multi-ton water cooled systems. Frequency range can be from sub 1Hz to 40kHz.

Designed for High Precision and Accuracy

The Spider analog input channels provide extremely high precision measurements. Each channel has single-ended or differential AC or DC input coupling. It can also provide IEPE (ICPTM) input mode (AC coupling with a 4 mA constant current from a 24 VDC source) for use with industry-standard accelerometers with built-in amplifiers. The ability to read TEDS (Transducer Electronic Data Sheet) identification from the attached transducer completes the channel's compliance with IEEE 1451.4.

In some models, built-in charge amplifiers are available. For pyrotechnic and other high-shock applications or tests involving very high DUT temperatures, each input channel can accept a charge-mode piezoelectric sensor input directly without using an expensive external charge amplifier.

Using our patented parallel dual analog-to-digital converter (ADC) design (U.S. Patent number 7,302,354), each measurement channel provides an unprecedented dynamic range of 160 dBFS (v7.7 and later) and can detect signals as small as 600 nV and as large as 20 V. This design eliminates the need for the input range or gain settings found on traditional controllers.

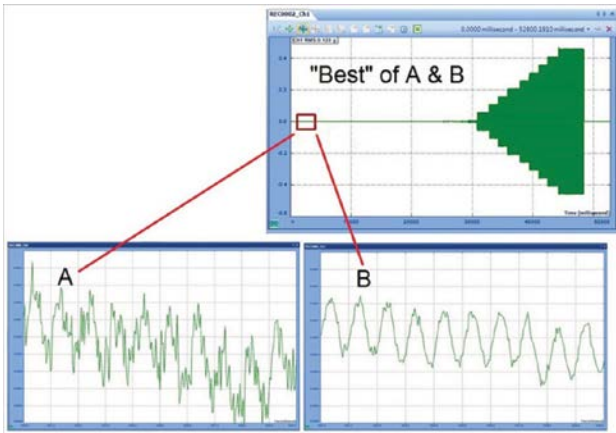

DSP knows how to pick the data from either A or B path, and “stitch” them together.

Simple Network Connection

Ethernet connectivity allows Spiders to be located far from their host PC. This distributed structure greatly reduces noise and electrical interference in the system. A single PC can monitor and control multiple controllers over a network. Since the control processing and data recording are executed locally inside the controller, the network connection does not affect control reliability. With wireless network routers, a PC connects easily to the Spiders remotely via Wi-Fi.

Time Synchronization between Multiple Hardware Front-ends with only Ethernet Cable

The Spider is built on IEEE 1588 Precision Time Protocol (PTP) time synchronization technology. Spider modules on the same network can be synchronized within 50 ns accuracy, which guarantees $\pm 1^\circ$ cross-channel phase match up to 20 kHz across the complete system. With this unique technology and high-speed Ethernet data transfer, the distributed components on the network truly act as one integrated system.

Black Box Mode

Black Box mode enables Spider operation without a PC. In this mode, a PC is used only to configure the control system before the system starts operation and to download data after the test is completed. During the test, the controller operates autonomously, according to a preset schedule.

On-Board LCD Display

The Spider-81 is equipped with a bright front-panel LCD and intuitive information navigation controls. Real-time status such as control RMS or sweeping frequency is instantly viewed on the LCD.

Designed for High Reliability

The Spider is the very first vibration control system designed for fail-safe operation even in the event of network or power loss. Advanced safety routines allow sensor failures to be detected within milliseconds. All Spider hardware pass strict environmental tests including EMI, temperature, drop shock, sine and random vibration. The system is built to withstand the rigors of the testing environment with long-lasting durability. The unique floating ground design reduces ground loop problems typically found in testing laboratories. Power backup circuitry based on a super-capacitor is installed to handle any disastrous power loss.

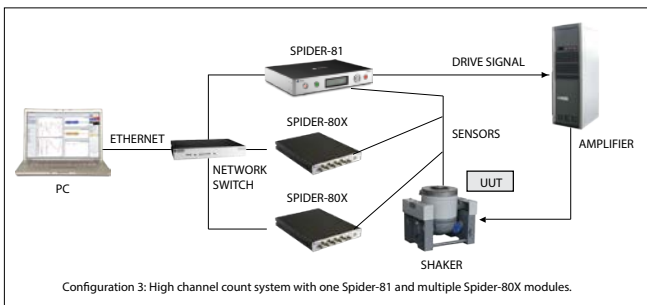
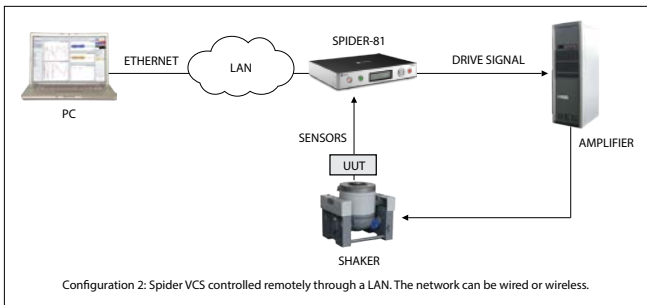
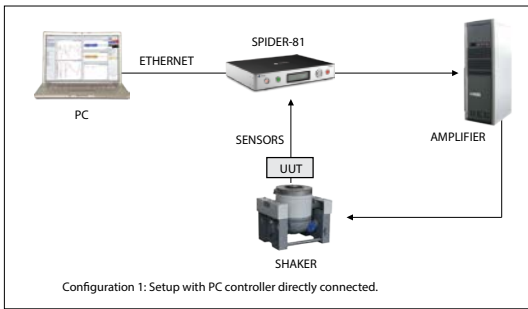



Designed for High Performance Control

By using enhanced control algorithms and a simplified DSP architecture, the feedback loop time of Sine and Random control are greatly reduced to a 10 ms latency. Reduced control loop time improves performance for resonance search and tighter control for a structure with high-Q resonances. It also provides faster adaptive responses for better safety protection.

Ease of Use

The Spider software is further improved at the user interface level. More graphical guidance, wizards, and tools are available to simplify test setup. The interface has been reformatted to be more intuitive. Event-Action Rules, Abort-Sensitivity, and numerous other new concepts are introduced in the software to simplify operation. Keyword searching through a large number of tests is easy. A smart network detection tool makes hardware installation very simple.

Designed for High Scalability and Expandability

With the Spider architecture, it is possible to make the hardware system ultimately scalable and expandable. A testing lab that purchases multiple front-ends of the Spider-81 or Spider-80X can freely move around their units and configure their own systems. For example, if a user purchases 8 Spider-80X front-ends, the user can use it as a 64 channel system, or separate them into two systems each with 32 inputs, or even into eight systems to control eight shakers each with 8 inputs.

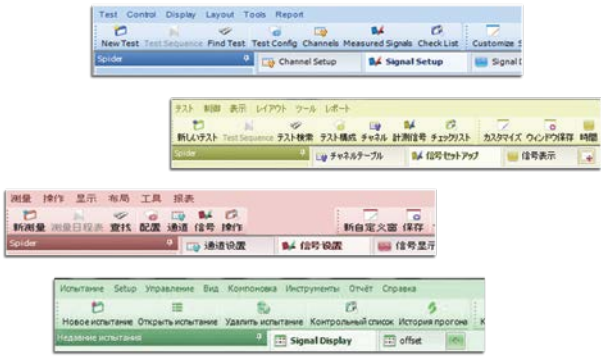

EDM (Engineering Data Management) is available in English, Japanese, Simplified Chinese, Traditional Chinese, and Russian.

Vibration Control Systems - Software Solutions

A Wide Range of Software Functions in Vibration Control and Signal Analysis

The Crystal Instruments vibration control system (VCS) software is designed for a wide range of vibration and shock testing customers. The VCS software suites support Spider hardware systems with as few as two input channels to systems with up to 512 input channels and multiple drive output capabilities. Software solutions for vibration control includes Sine, Resonance Search Track & Dwell (RSTD), Oscillator, Random, Sine-on-Ransom (SoR), Random-on-Random (RoR), Swept Random-on-Random (SRoR), Classical Shock, Transient, Seismic, Shock Response Spectrum (SRS) Synthesis, Time Waveform Replication, multi-shaker control and a range of MIMO control functions. The VCS software is fully integrated into the combined test environment which includes controls to temperature, humidity, pressure, strain, torque and other quantities.

The same Spider hardware running VCS also supports a wide range of dynamic data acquisition and real-time processing functions including Fast Fourier Transform (FFT), Frequency Response Function (FRF), real-time filters, octave and sound level meters, order tracking, automated limit testing, transducer calibration and a comprehensive suite of modal testing and analysis.

Multi-Language Support

Crystal Instruments' EDM fully supports software interfaces in English, Japanese, Simplified Chinese, Traditional Chinese or Russian. The selected language can be changed without re-installing the software.



Step 1:
EDM sets the alarm limit together with a special message string, such as "Exceeding Limit".



Step 2:
When an alarm event happens, the customized string, "Exceeding Limit" will be sent to the EDM Cloud email service.



Step 3:
User will receive an alarm email



Easy Network Configuration

Intelligence has been built into the software so that the hardware devices on the network can be detected and accessed with little effort. A Security Access Code (SAC) is used to protect unauthorized access to the hardware on the network.

Multi-Tab and Multi-Screen Support

To support the high channel count system that may display up to hundreds of signals, the software is designed to support multiple tabs and multiple screens. The highly flexible online display capabilities are expandable, making monitoring high-channel count systems quicker and easier. Display layouts for each tab and screens can be set up and stored for rapid access.

Safety First

Our software and hardware utilize many safety features to ensure reliable closed-loop vibration control – from pretest checks to abort checking, notching and controlled shutdown during a test. The check-only mode allows checking the connection of sensors and verifies the amplifier status before turning the drive output on. This pretest function is an extremely powerful tool for detecting possible set-up problems before your test is started. During closed-loop control the VCS software performs RMS and line-by-line abort checks, sigma clipping and drive limitation and continuously checks for open channels and overloads. The software carefully checks for open-loop conditions such as failure of a sensor connection and verifies proper response during the initial drive ramp-up. During every test, the shaker limits (peak acceleration, velocity, displacement), maximum drive voltage and sensor connection status are continuously monitored and will initiate an emergency shutdown in case of any deficiency.

Multi-Tasking

With DSP centralized hardware architecture, the real-time measurement and control processes are all run on the front-end hardware; users can utilize all of the capabilities of the host computer for other tasks. This multi-tasking concept guarantees powerful and time efficient vibration testing, even with time critical tests. More importantly, it provides a unique and important safety feature: any computer or network failure will not affect the vibration control.

Test Sequence

A Test Sequence provides the capability to automatically execute a sequence of tests. The user can Run, Pause or Stop the testing at any time and the software keeps a detailed log of the actions and results.

Event-Action Rules

Event-Action Rules is a new way to customize the controller behavior. Many events that can occur during the course of test operation, including certain response levels being reached, limits being exceeded, and user events such as Pause or Stop. Event-Action Rules define the response of the controller to these test events. Many actions are available as custom responses, such as sending an e-mail, send a digital output signal to the climate chamber or stopping the test.

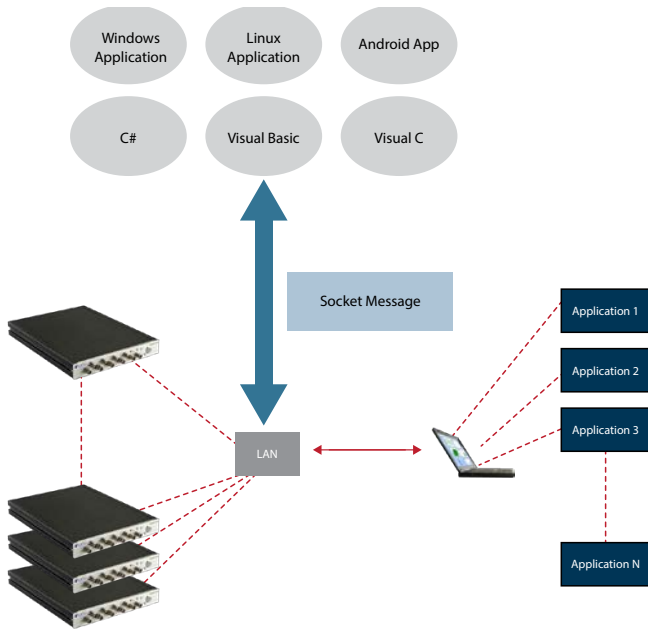

Connectivity to Other Software, Hardware and You

Various approaches have been developed to establish the connectivity between the EDM software and other applications, such as climate chamber software or an amplifier controller. Socket messages, a common language that runs on nearly all operating systems and hardware platforms, is used to send and receive messages between EDM and other software. A digital input/output hardware interface is also provided on every Crystal Instruments product, which enables interfacing to other hardware devices. Test status reports can be sent via email or SMS text message to your mobile phone, enabling you to decide whether to return to work or not within minutes of the test stopping.

Continuous Time Data Recording

The Spider platform is capable of recording the data of 512 control/monitor input channels sampled at up to 102.4 kHz. The storage can be either internal flash memory or a dedicated solid-state drive. The reliability of the software for such real-time data transfer has been fully validated. Continuous recording happens in parallel with vibration control and neither is affected by the other.

Database Technology

By using latest database technology, EDM can quickly search, index and organize the testing setup and data. On the company network different testing stations can share the same database.

Location ID and Customized Signal Labeling

In EDM, signals can be clearly labeled with names conveying physical meaning, such as "Top" or "Front". All related signals will be renamed with such labeling automatically.

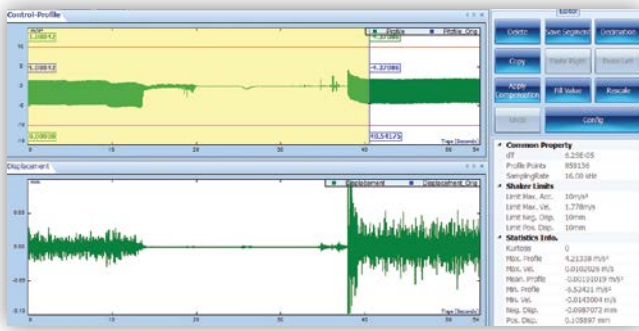

Check List for the Initial Startup

EDM can show an overview of the critical parameters to be verified before a test is started.

Flexible Math Function

EDM software provides flexible math functions to perform block arithmetic on signals using +, -, *, / or other arithmetic operations. Math functions can be applied in both time and frequency domains.

Non-Acceleration Measurements

Any input channel can measure any type of physical signal such as displacement, temperature or pressure.



Remote Operation Communication Using Socket Messages

Communicate with and control Spider systems remotely with Window socket messages. Socket messages also allow communication with other hardware, such as temperature chambers. With the Socket Message protocol, Crystal Instruments' controller can be accessed from LabView, Matlab or other customized software running on Linux, MacOS, or Windows operating systems. Please refer to the Socket Message Specifications for further details.

Shaker Parameters

Shaker parameters are saved to the library and used repeatedly in different tests. The library can be imported from or exported to a Microsoft Excel spreadsheet.

Multiple VCS instances

Launch multiple EDM VCS instances on one computer. Each instance of full-featured VCS software connects to one controller that drives one shaker. Each instance runs the vibration control test individually. All instances may run different test types or the same test type. The operator performs the tests and monitors the test status from the same computer, where all reports and signals from multiple instances are saved to for better management.

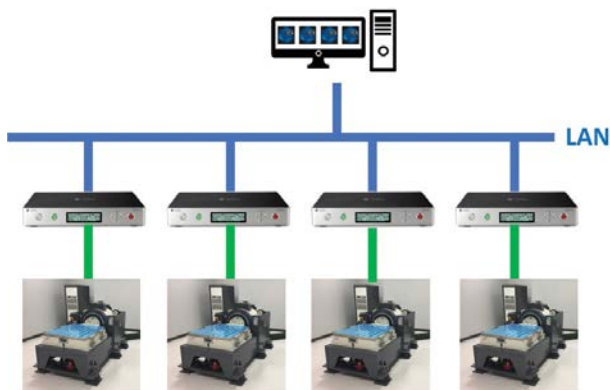

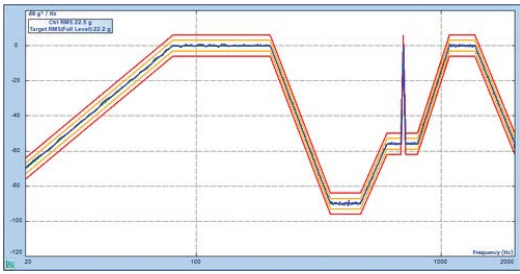

Random Vibration Control

Random Vibration Control provides precise multi-channel control in real time. The device under test is subjected to true random noise with a precisely shaped spectrum with either Gaussian or non-Gaussian amplitude statistics.

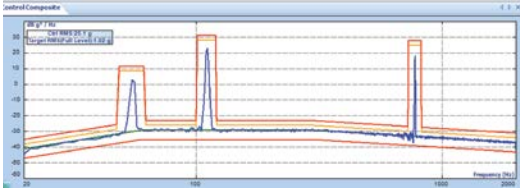

Sine on Random Control

Up to 12 independently sweeping controlled sine tones may be added to the broadband random signal. Each sine tone has its own sweeping schedule and range. Tones can be turned on and off manually or by a predefined schedule.

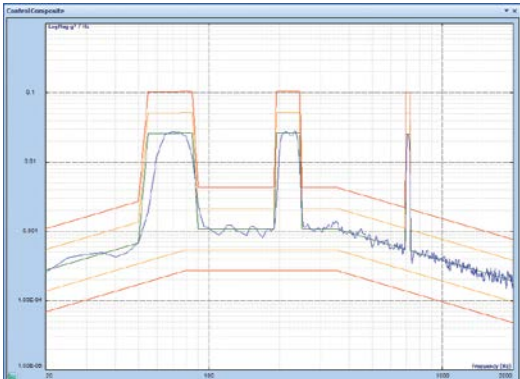

Random on Random Control

Up to 12 independent (stationary or sweeping) random narrow-band signals may be superimposed on the broadband random signal. Each narrow-band has its own sweeping schedule and range. They can be turned on and off by a predefined schedule or manually.

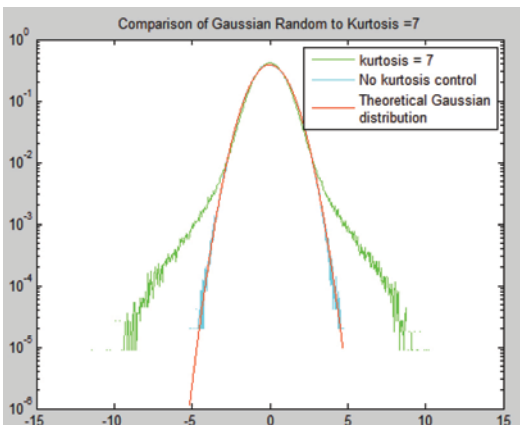

Kurtosis Control & Drive Clipping

Kurtosis control can provide a more damaging non-Gaussian random control time history. A unique patent pending technology can generate a non-Gaussian control time history while precisely maintaining its spectrum shape.

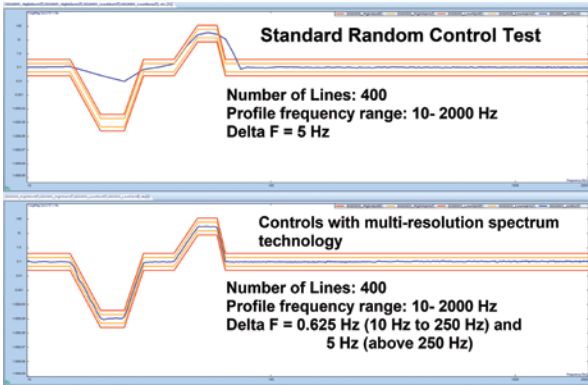

Multi-Resolution Control

The Multi-Resolution function applies the selected resolution in the high-frequency range and 8 times of the resolution in the low-frequency range. It perfectly fulfils the requirements of many Random profiles having details in the low frequency range and up to 2 kHz. Adequate loop time, spectrum refresh rate, and storage are maintained without using high resolution (large block size) that is not needed in the high frequency.

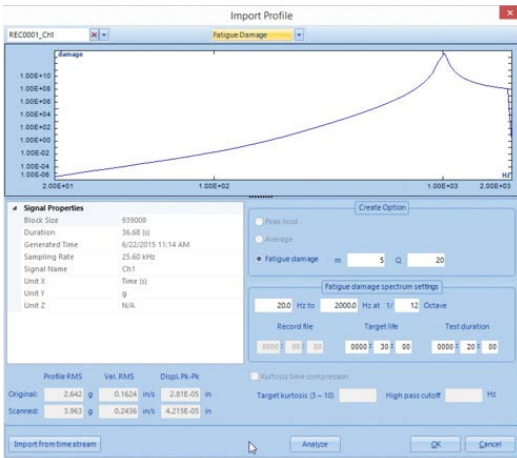

Fatigue Damage Spectrum

Fatigue Damage Spectrum (FDS) allows users to compare the potential damage caused by different Random and swept sine profiles. In a similar fashion to Multi-Sine Control, FDS provides a way to reduce testing times by calculating the quickest path to destruction or damage.

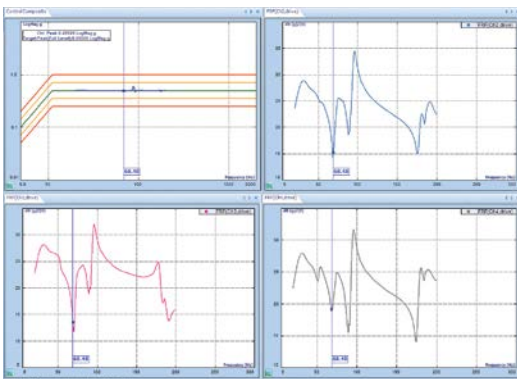

Swept Sine Control

Swept Sine Vibration Control provides precise multi-channel control in real time. It provides a spectrally pure undistorted sine wave and a control dynamic range of up to 100 dB. As many as 512 channels can be enabled for Control, Notching, Monitoring and time-data recording.

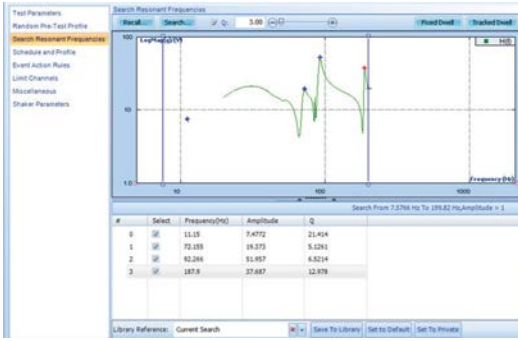

Resonance Search and Tracked Dwell (RSTD) Control

The resonance search function determines resonant frequencies from the peaks of a transmissibility signal. Dwell type (Fixed dwell, Tracked dwell, Phase tracked dwell) may be specified manually (with a list of resonance frequencies) or automatically executed after a resonance search is done.

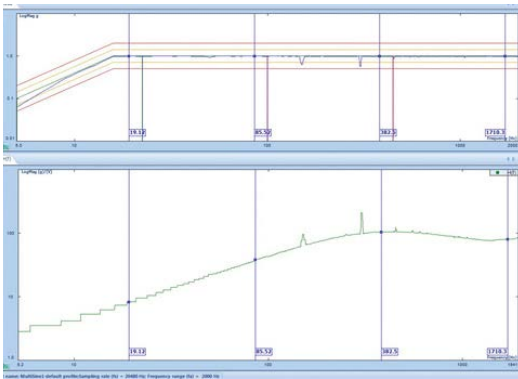

Multi-Sine Control

Multi-Sine control enables multiple sine tones sweeping simultaneously and ensures that multiple resonant frequencies of the structure can be excited. With multiple sine tone excitation, the required time duration of sine testing can be reduced significantly.

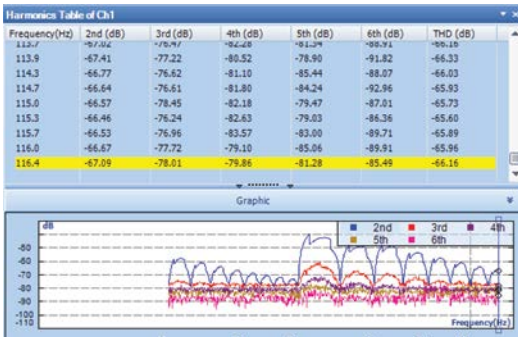

Total Harmonic Distortion (THD) Measurement for Sine

This option adds the ability of computing Total Harmonic Distortion (THD) of the control and Input signals. THD plots can be generated while drive signal either steps through multiple discrete frequencies or a swept sine tone within a predefined range.

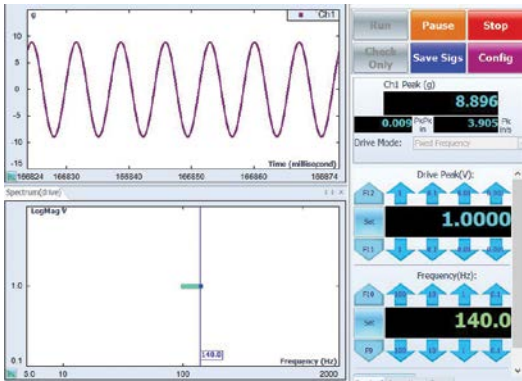

Sine Oscillator

Sine Oscillator is a diagnostic tool providing manual control of the sine output while the system displays various time signals and frequency spectra. Random excitation can be enabled as a checkup function. When the close-loop option is enabled, the Sine Oscillator is essentially a limited sine controller with augmented manual control functions.

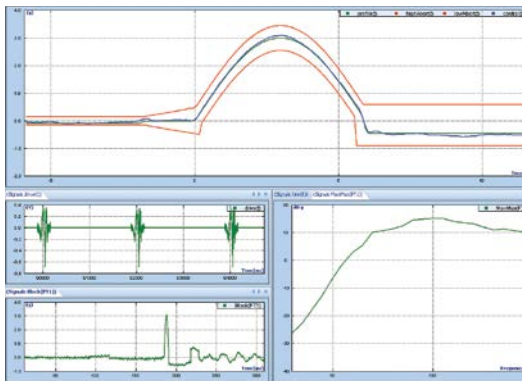

Classical Shock Control

Classical Shock Control provides precise, real-time, multi-channel control and analysis of a transient motion in the time domain. Classical pulse shapes include half-sine, haversine, terminal-peak sawtooth, initial-peak saw tooth, triangle, rectangle, and trapezoid. Applicable Test Standards include MIL-STD-810F, MIL-STD-202F, ISO 9568 and IEC 60068 (plus user-defined specifications).

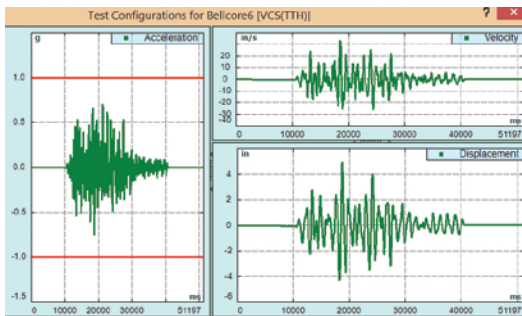

Transient Time History Control (TTH)

Targeting seismic simulation applications, TTH controls shaker motion to match any user defined transient waveform. Time waveforms can be imported to EDM in various formats. Scaling, editing, digital re-sampling, high-pass or low-pass filtering and compensation will tailor the waveform so that it may be duplicated on a particular shaker.

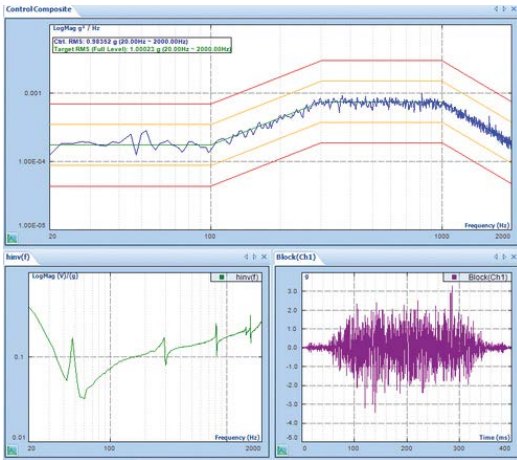

Transient Random Control

Transient Random control applies a chain of pulses with random nature to the shaker. The target profile power spectrum is defined in a same way as Random control, with the addition of defining transient pulse interval. Applications includes gunfire simulation or road simulation.

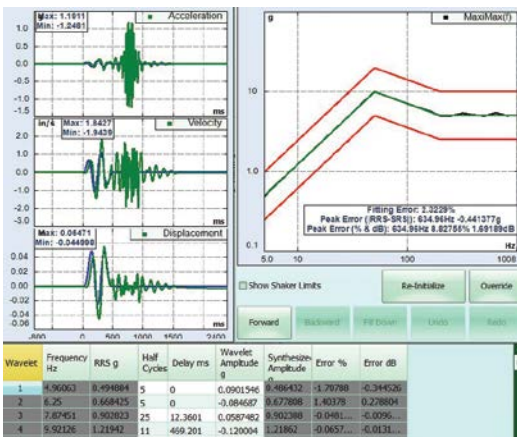

Shock Response Spectrum (SRS) Synthesis & Control

The SRS synthesis and control package provides the means to control the measured SRS of the DUT to match a target SRS, the Required Response Spectrum (RRS). The necessary drive time history is synthesized from damped-sine or sine-beat wavelets. Damped Sine Parameters include frequency, amplitude, critical damping factor, and delay. Waveforms may be automatically synthesized from a user-specified SRS reference profile.

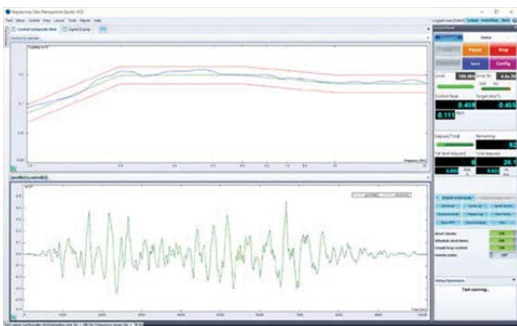

Earthquake Testing Control

The earthquake testing control package provides controls to meet a target a Required Response Spectrum (RRS). Waveforms are automatically synthesized from a user-specified SRS reference profile using random type of wavelets, uniform or shaped. Alarm and Abort tolerances may be applied to any active channel to provide an extra degree of safety for delicate test articles.



Time Waveform Replication

Time Waveform Replication (TWR) provides precise, real-time, multi-channel control for long duration waveform duplication. TWR includes the Waveform Editor, a flexible importing and editing tools for long waveform signals. The Recording option records time stream data at the full sample rate on all input channels.

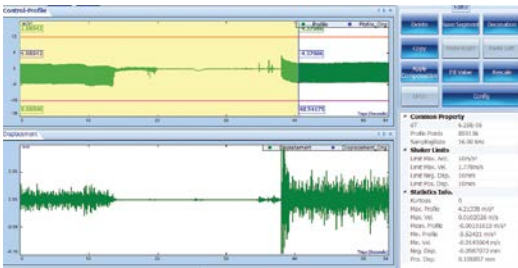

Waveform Editor

Profile Definition: Any existing signal is treated as a profile and is imported and defined as a control.

Profile Editing: Waveforms with any sampling rates are digitally resampled, re-scaled, filtered, and different compensation techniques may be applied to edit the profile using the EDM – Waveform Editor tool. Options for cropping, appending and inserting parts of a waveform are also provided

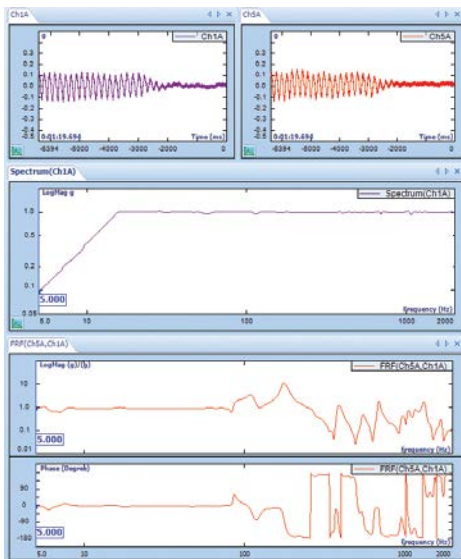

Real-time Sine Reduction

Real-time sine reduction offers a solution to extend the number of measurement channels of a vibration controller system in a swept sine test. This software is run by a Spider system while an independent vibration controller controls the shaker. The sine reduction application calculates the same time and frequency functions as the controller, but using its own input signals. This function requires a COLA signal from the vibration controller system for instantaneous frequency, phase detection, and spectrum analysis.

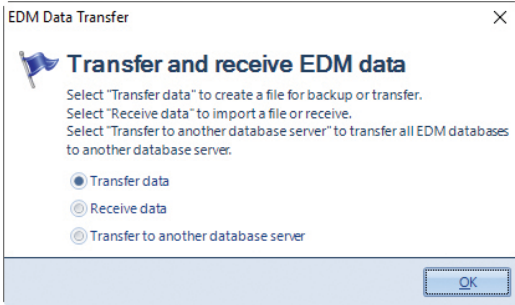

Data Transfer Tool

The Data Transfer Tool is installed with EDM. It transfers all EDM databases (including tests, parameters, and saved files) from a local computer to another over LAN or storage media (e.g. flash drive, DVD, ...). In addition, databases can be transferred between SQL server instances. The transfer and receive process can also be treated as a backup and recovery process. The step-by-step wizard guides the user through the whole process.



Sensor Calibration

The Sensor Calibration tool is used to calculate the sensitivity of sensors while the measurements of the sensors are compared against referenced sine-wave input signals. The user enters the following information: calibration signal nominal frequency, either RMS reading or dB RMS, and a reference (0 dB) value. The front-end automatically calculates the RMS levels and updates the sensitivity table. The user accepts or rejects the calibration results and views the reports.



Versatile Report Functions

The EDM software generates test reports from pre-defined templates. Users can customize the logo, margins, orientation of the paper, font formats, and contents of the test reports. The reports can export as OpenXML, PDF, or Microsoft Word file types for convenient usage. A word processing program does not need to be installed in order to create reports. With ActiveX reporting, signal displays in the report can be rescaled, analyzed, and zoomed.

- Users can select from various templates for creating reports
- Plot reports can be generated by simply right-clicking the mouse
- Company logos can be inserted into the template header or footer
- Reports can export as WORD, OpenXML or PDF format
- “Active Report” allows the user to ZOOM in and out like a graph on the report
- Generate typical hardware calibration reports

Calibration Report

Product model:	Spider 81	Software:	Front end software 6.1.0.2
Manufacturer:	Crystal Instruments Corporation	Hardware:	7.4.1
Product Serial Number:	1224597		
Calibration:		Report No.:	3453466
Calibration Date:	Dec-30-2018	Operator:	T. M.
Calibration Due:	Dec-30-2017		
Description:	Amplitude accuracy at DC and 1 kHz and Frequency Response from 3 Hz to 40 kHz. See attached calibration table and graph.		
Parameters tested:			
Environmental conditions:			
Actual Temperature:	21 degrees C		
Relative Humidity:	60%		
Location:	San Diego, CA, USA		
Procedures used:	Input and output calibration and adjustment (factory procedure)		
Received condition:	<input type="checkbox"/> In tolerance <input type="checkbox"/> Out of tolerance <input type="checkbox"/> Damaged <input type="checkbox"/> New uncalibrated box <input type="checkbox"/> Other		
Return condition:	<input type="checkbox"/> In tolerance <input type="checkbox"/> Out of tolerance <input type="checkbox"/> Damaged		
Signature:	Comments:		

Standard utilized	Model number	Serial number	Cal Date	Due Date	Traceability cert. No.
Manufacturer	Mean Model				
Fluke		810462	2018-09-22	2017-08-22	987654

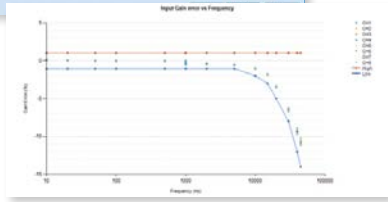
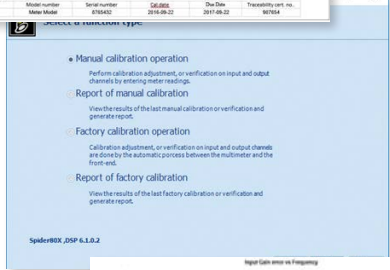

Front-End Calibration Tool (FECT)

All products are calibrated at the factory prior to shipping and should be recalibrated annually by a factory authorized calibration service. The optional calibration tool existing before EDM 6.1 release is replaced by FECT, which provides a basic adjustment and is operable by the user or a calibration specialist. Reports can be generated from EDM or FECT.

For a more comprehensive calibration report, which provides as found and as left data measured at different frequencies, contact Crystal Instruments or an authorized calibration service provider for more information.

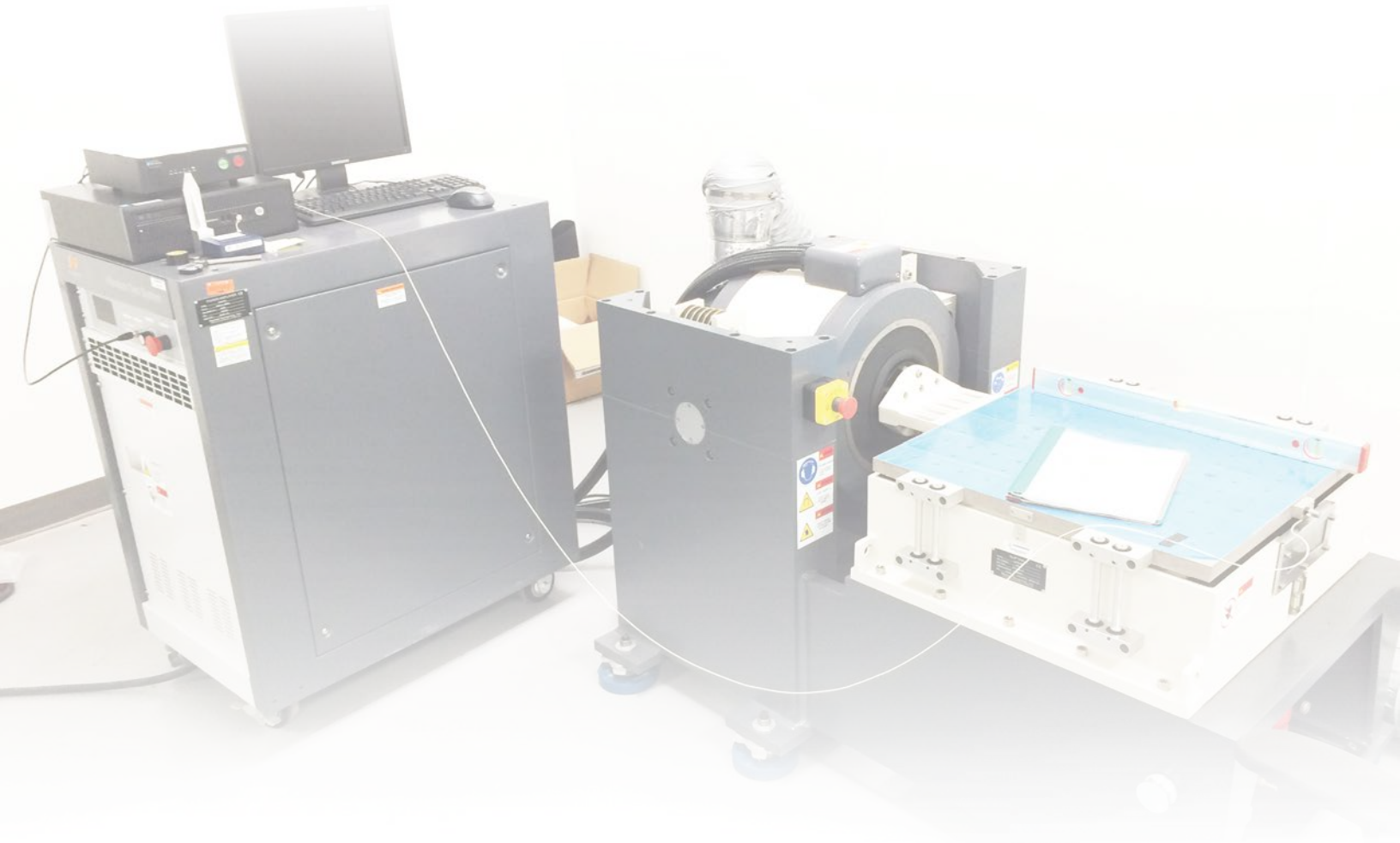

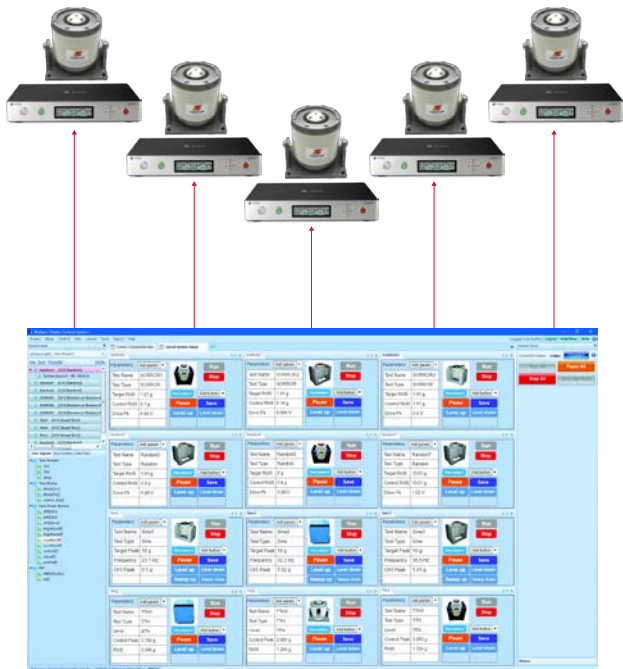

Multi-Shaker Control from One Application

The multi-shaker control function is specifically designed for production applications, where the operator wants to observe and command multiple shaker tests from one PC station. The operator can manage the entire testing configuration from one EDM instance at their workstation – this includes observing the testing status, viewing individual signals from different shaker systems, and sending commands to each controller.

Spider systems are not limited by bandwidth in their number of controllers – the ethernet connectivity of Spider systems allows for any number of connections. For practical reasons we limit the number of controllers that EDM can access to 12.

Customizable Status Display

The status display for each individual shaker controller can be customized. For example, you can display the Peak value for a Sine controller and the RMS value for Random. These can be displayed on one screen.

Customizable Individual Command Panel

Commands for each controller are customized. Some panels can have Start/Stop/Pause, and other panels can show Sweep Up/Down.



Run Different Type of Tests

Different types of tests can be mixed and loaded into this application together. Random, Sine, TTH or Shock can run in the same test duration.

Common Commands

Several common commands have been implemented – these commands can be applied to all controllers at once. All the tests can be started or stopped by pressing one button.

Robust Tolerant Design

Robust software design allows for tests to run without being interrupted by the failure of other tests. If one test failed for any reason, the other tests will continue, until the operator wants to stop them.

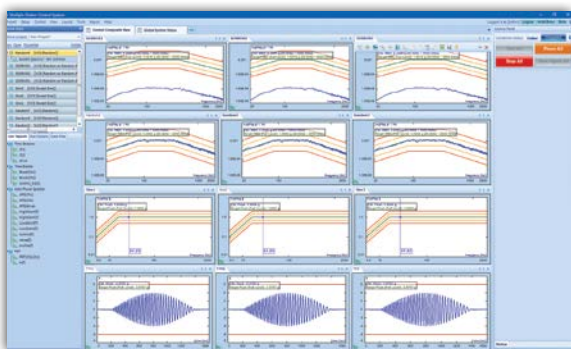

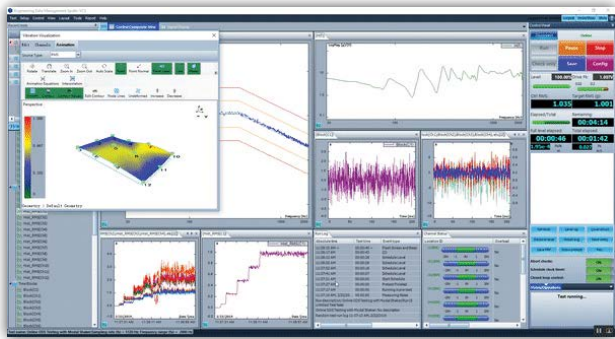

Vibration Visualization

The EDM Vibration Visualization feature is available in **all test types of EDM VCS software**. This option provides fast and efficient structural model generation and full 3D visualization of the online vibration pattern on the structure under test. There are three tabs to cover the geometry model editing, input channel DOF mapping, and operational deformation shape animation.

The first tab (**Editor**) is designed to help users create the geometric models for viewing the operational deflection shapes of the test structure. The second tab (**Channels**) allows the user to assign the corresponding DOF information to each enabled input channel. The third tab (**Animation**) displays the deformation animation of the operational deflection shapes of the structure under test. **Block** and **RMS** data from the input channels can be used for the vibration visualization of the operational deflection shapes.

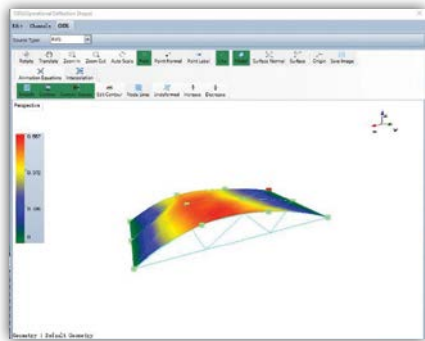
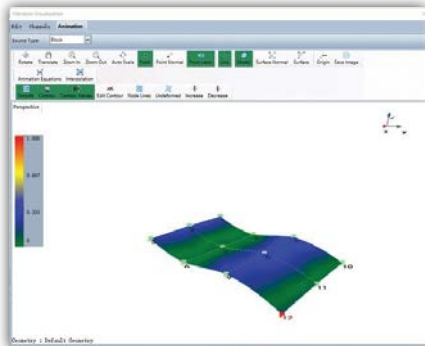

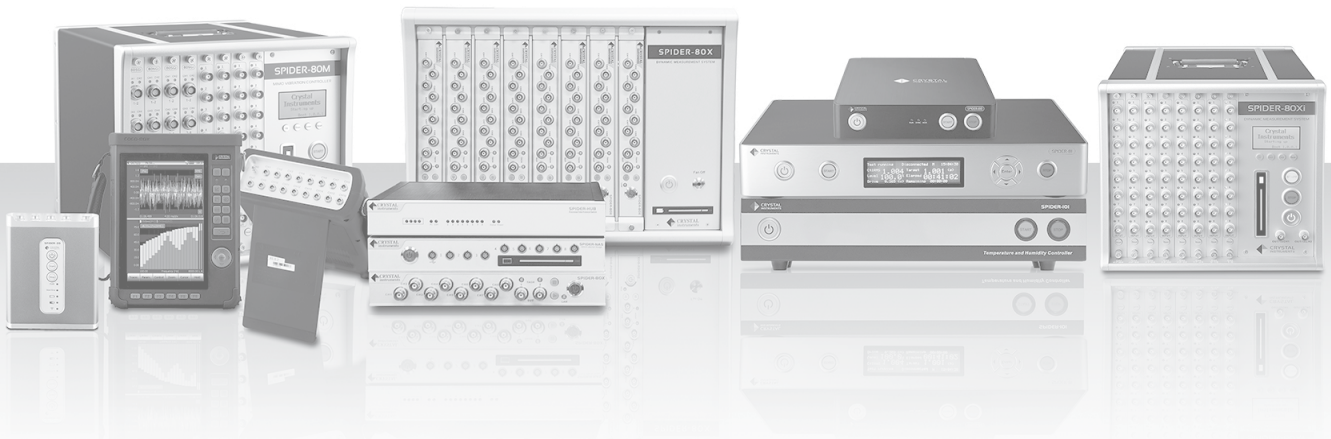

Crystal Instruments understands the enormous investment our clients put into our products. We match their investment by offering the most comprehensive technical support agreement in the industry. From support calls to staff training, Crystal Instruments provides solutions to our customers' needs.

The "Comprehensive Technology Support Agreement" offered by Crystal Instruments is fairly priced as a small percentage of the total purchase value. The services offered and included in the agreement are for the duration of 1 year. The agreement is renewable at a locked in rate as a subscription. Rates are subject to increase if a subscription is not continued at the time of renewal and signed up for at a later time. Please contact Crystal Instruments for pricing information.

Services offered are:

- Annual software upgrade program - accessible by convenient online downloads
- Annual hardware calibration
- Priority phone/email/live video support from highly trained engineers
- Temporary replacement unit for hardware in 48 hours
- Data recovering services
- Hardware repair when the total service hours required is less than 4 hours per incident

Annual Hardware Calibration

Crystal Instruments DMS is certified by ISO:9001. Hardware calibrations are also performed at the customer's site upon request. Customers with a Premier Technology Service Agreement will receive standard annual hardware calibration services at no additional cost (a \$1500 value).

Annual Software Upgrades

Crystal Instruments provides convenient solutions for software upgrades. Users are able to download the latest versions of Crystal Instruments' Engineering Data Management (EDM) software through the support website.

Other options include emailed links to download software updates, physical CD-ROMs sent to your location, and installation instructions provided over the phone by our highly qualified Applications Engineers. Customers with a Premier Technology Service Agreement will receive standard software update services at no additional cost.

Temporary Replacement Units

Crystal Instruments strives to minimize any inconvenience to our customers' operations. Temporary replacement units are often provided to customers as a solution. Units will usually be assigned to customers within 48 hours or less.

Live Product Support

Crystal Instruments support staff is based in Santa Clara, CA at our corporate headquarters. Our support staff provides phone and email support from 8am to 5pm PST, Monday through Friday. All support is provided by highly trained engineers, not technicians. After hours support is also available upon request.

Crystal Instruments' highly diverse staff provides native language support in English, Spanish, Mandarin, Cantonese, Japanese, Taiwanese, Persian, Hindi, and Vietnamese.

Hardware Repair Services

Crystal Instruments provides hardware repair for units estimated to have a 4 hour or less repair service period. Additional hours required for repairs are charged at an hourly rate. Replacement parts are discounted by 30% under the Premier Technology Support Agreement. All hardware repair takes place at Crystal Instruments headquarters in Santa Clara, CA. Our highly trained technicians will accurately and efficiently repair your equipment in our ISO:9001 certified facilities.

Data Recovery Services

Crystal Instruments understands the importance of recovering any lost data safely and securely. Our staff is ready and available to assist you through any data loss crisis.

To find a distributor near you, please visit our website:

CRYSTAL INSTRUMENTS

2370 OWEN STREET
SANTA CLARA, CA 95054 (USA)

PHONE: +1-408-986-8880
FAX: +1-408-834-7818

EMAIL: INFO@GO-CI.COM
WWW.CRYSTALINSTRUMENTS.COM

© 2019 Crystal Instruments Corporation. All Rights Reserved. 05/2019

Notice: This document is for informational purposes only and does not set forth any warranty, expressed or implied, concerning any equipment, equipment feature, or service offered or to be offered by Crystal Instruments. Crystal Instruments reserves the right to make changes to this document at any time, without notice, and assumes no responsibility for its use. This informational document describes features that may not be currently available. Contact a Crystal Instruments sales representative for information on features and product availability.