

ARTES

ARTES 460 | 600

Automatic Relay Test Systems

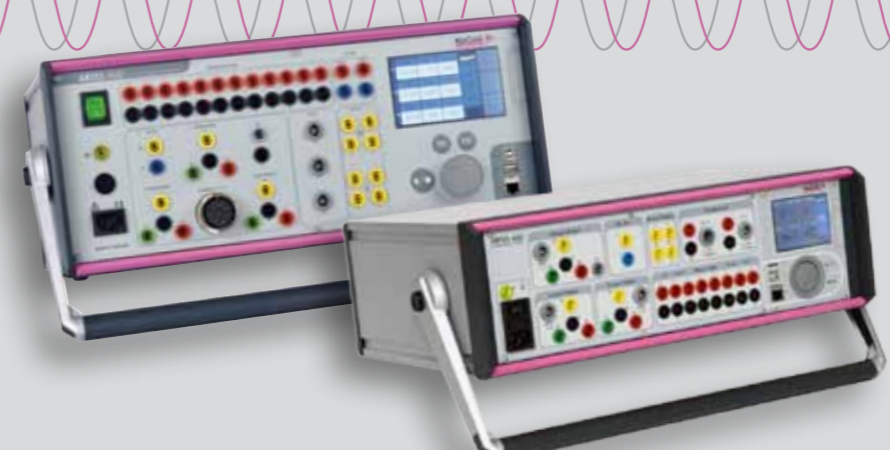
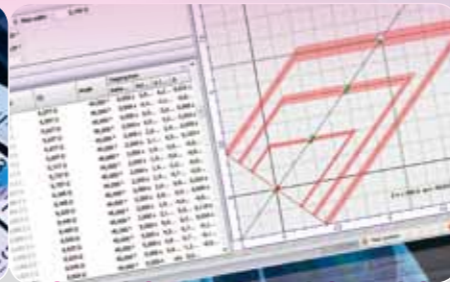

KoCoS Messtechnik AG
Südring 42
34497 Korbach, Germany
Tel.: +49 5631 9596-40
info@kocos.com
www.kocos.com

Subject to change without prior notice | 201805 | © KoCoS Messtechnik AG



KOCOS MESSTECHNIK AG



CONTENTS

ARTES Automatic Relay Test Systems	3
Product overview	4
Technical data ARTES 460 600	5
Applications.....	6
System description	7
Current and voltage amplifiers.....	7
Equipment and handling	10
The ARTES testing software	14
ARTES test monitors.....	18
Overview of test monitors	29
Software modules and packages.....	29
Options and accessories	30
Device options.....	30
Cable sets	30
Adapters.....	32
Wrap-around bags and carrying cases.....	33
Training courses and seminars	35

ARTES

AUTOMATIC RELAY TEST SYSTEMS

The purpose of power system protection is to use accurate and reliable protection equipment to recognize faults in the supply system promptly and without fail and to minimize impairments to the power supply by selectively switching off faulted sections of the power system.

The use of suitable protection devices can significantly improve the safety and reliability of complex electrical power systems and installations. Regular testing is the only way to ensure that these protection devices function correctly throughout their operational life.

More than 20 years of experience in developing and manufacturing automatic relay test systems have gone into creating the fourth generation of ARTES test instruments. Back in 1996, KoCoS was the first company to present Windows-based testing software for controlling and operating test equipment and the company continues to play a pioneering role in the design of clearly structured and ergonomic user interfaces today.



ARTES

PRODUCT OVERVIEW

ARTES 460|600 test systems are practical solutions which can cope with just about any relay testing task.

ARTES 460

Compact test system for three-phase tests, can be used as a universal tool for testing digital protection relays.



ARTES 600

Compact test system for highly complex test tasks. 4 voltage outputs and 6 current outputs which can provide particularly high output power allow three-phase tests on static, digital and self-powered relays.



Technical data ARTES 460|600

	ARTES 460	ARTES 600
Sources Frequency range Transient signals Phase angle	4 voltage and 6 current outputs DC...3 kHz DC...4 kHz 0...360°	
Voltage outputs 4-phase (L-N) 1-phase (L-L)	4 x 0...300 V / 75 VA 1 x 0...600 V / 150 VA	
Current outputs 6-phase 3-phase 1-phase	6 x 0...16 A / 40 VA 3 x 0...32 A / 80 VA	6 x 0...32 A / 250 VA 3 x 0...64 A / 500 VA 1 x 0...96 A / 500 VA
Low-level signal outputs	10 separately and independently adjustable outputs, output range 0...10 Vpk	
DC output	12...260 VDC, 50 W, max. 2 A	
Analog inputs	2 switchable measuring ranges: 4 x 0...±10 V / 600 Vrms 4 x 0...±20 mA / 0...±10 V	2 x 0...±20 mA
Multi-function inputs Measuring ranges Frequency range Response threshold/range	12 inputs in 6 galvanically isolated groups 2/10/300/600 VAC/DC DC...6 kHz Freely adjustable, or potential-free contact	
Binary inputs Configuration	8 inputs in 2 galvanically isolated groups Wet or dry contact group	
Binary outputs	2 potential-free, galvanically isolated relays	2 potential-free, galvanically isolated relays 2 transistor outputs
Operation PC Stand-alone	ARTES testing software for Windows® XP/7/8/10 3.5" touch screen, high-resolution, resistive, 2 function keys, Jog wheel	
Measurement connections	All the connections are located on the front panel. This means that ARTES 460 600 can also be operated in an upright position.	
Interfaces	USB, Ethernet	USB, 3 x Ethernet, Wi-Fi
Time synchronization	Optional GPS module	Internal GPS receiver
Status LEDs	Indication of active current and voltage outputs and of the status of the binary inputs and outputs by LEDs	
Supply voltage	100...265 VAC, 47...63 Hz / 120...265 VDC	
Housing Dimensions (mm) Weight	19" housing, 3 U, handle serves as stand 470 x 162 x 326 (W x H x D) 11.7 kg	19" housing, 4 U, handle serves as stand 470 x 202 x 326 (W x H x D) 15.9 kg



Applications

ARTES 460|600 test systems are used to carry out function tests and tests of configured starting and tripping characteristics, including any automatic reclosing functions of protection devices such as:

- Distance protection relays
- Differential protection relays
- DT/IDMT relays
- Voltage relays, frequency relays

They can also be used to test and calibrate power, voltage, current and frequency converters.

With four voltage outputs and six current outputs, even highly complex tests on static, digital and self-powered protection relays can be carried out without additional equipment. The calculation of test quantities and the control of tests are carried out fully automatically.

SYSTEM DESCRIPTION

ARTES 460|600 test instruments have been specially developed for harsh transport and operational conditions. Thanks to state-of-the-art technology, the fourth generation of ARTES products have retained the positive features of their predecessors, even though they have more power and more channels. A high level of system integration make it possible to accommodate these compact systems in a 19" housing while keeping their weight down to a minimum at the same time. A very effective cooling system and automatic fan control reduce the noise generated by the test instruments to a barely perceptible level.

Current and voltage amplifiers

ARTES 460|600 test systems have four voltage outputs and six current outputs.

The test quantities are monitored constantly by means of an internal feedback measurement of the output signals.

Test currents of up to 96 A with parallel operation

The current amplifiers of the ARTES 600 provide a maximum test current of 6 x 32 A. Parallel operation of the current outputs allows output of up to 3 x 64 A for 3-phase applications and up to 96 A for 1-phase applications.

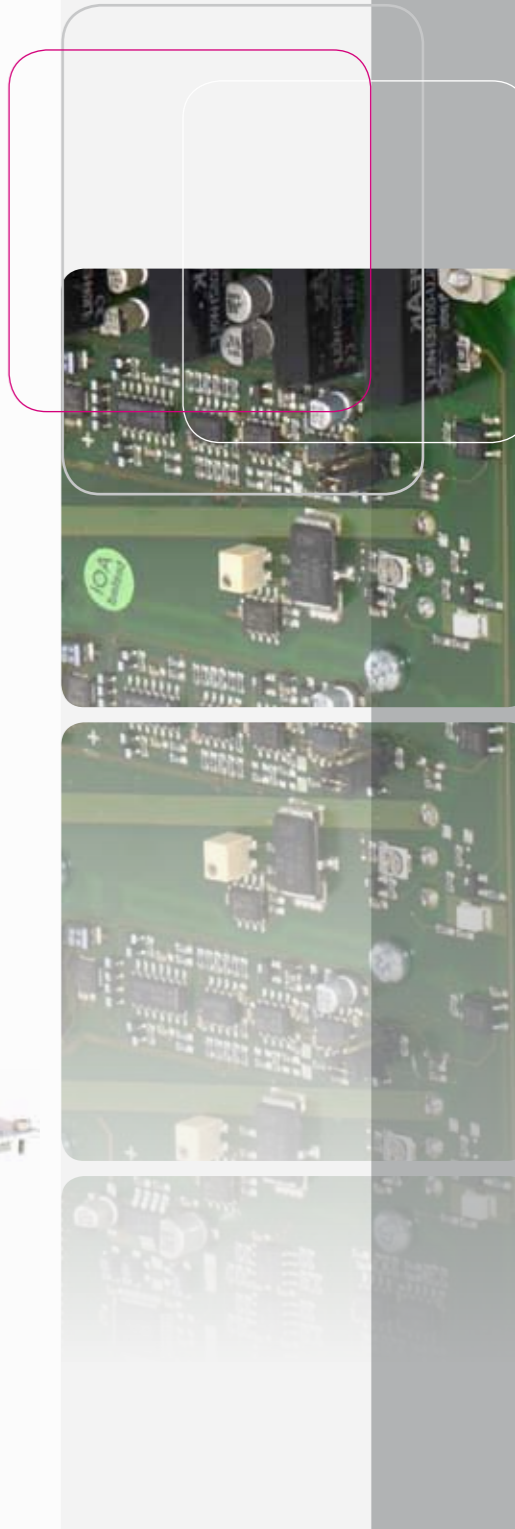
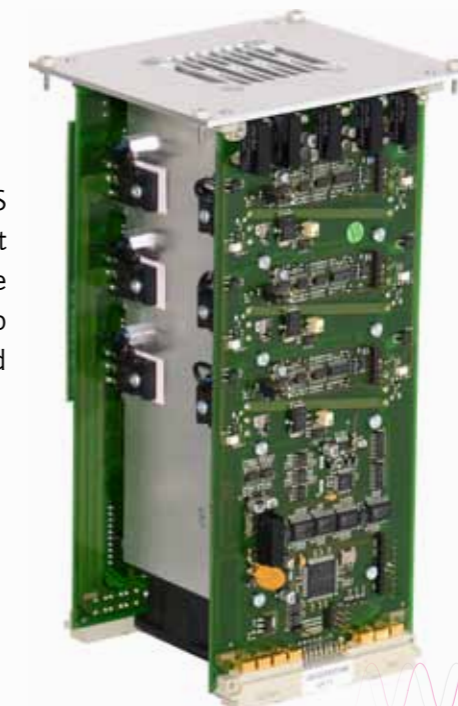

Constant output signals for changing burdens

Even if the burden of the device under test changes during output, constant output signals with very high accuracy are guaranteed. Synthetic signal generation with a powerful signal processor, internal feedback measurements of the output signals in real time and ultra-fast regulation of the amplifiers make this possible and ensure that the signals always correspond exactly to the desired value set for them, even during output.

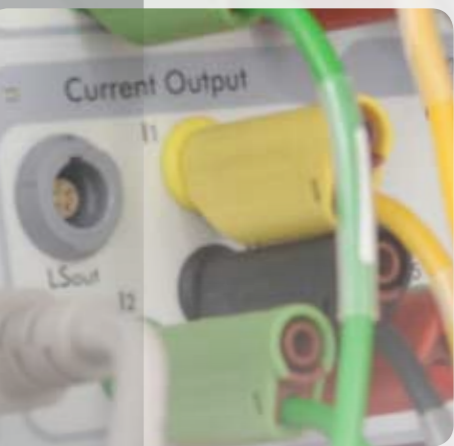
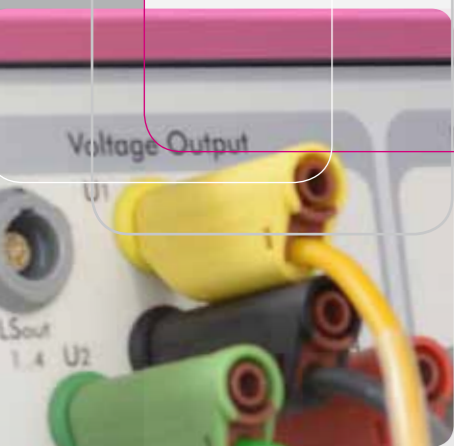

Wide frequency range for output of transient signals

The fully electronic amplifiers of ARTES 460|600 do not feature any transformers in the outputs. It is therefore possible to generate output signals in a wide frequency range of several kHz. In addition to self-generated signals, records from fault recorder systems can also be output as transient signals.

Immunity to disturbances in the power supply

Powerful, wide-range switching mode power supplies safeguard the power supply to the ARTES amplifiers and ensure fault-free operation and constant output signals. Changes to the output quantities are completely eliminated, including inaccuracies and errors resulting from fluctuations in the supply voltage.

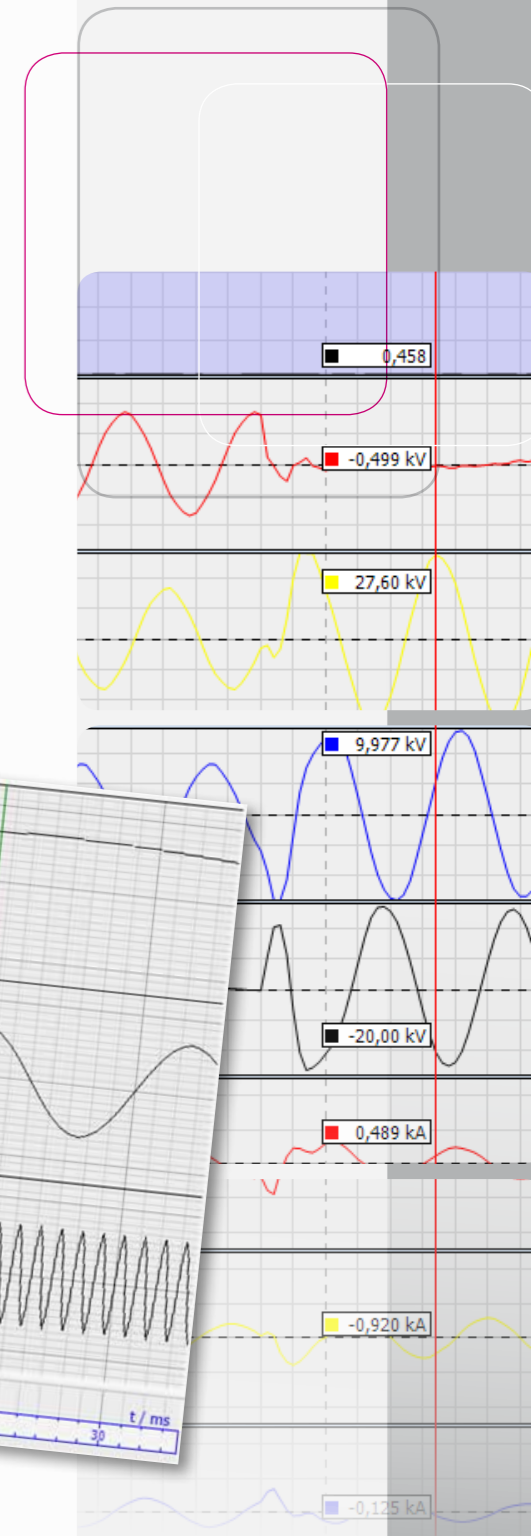
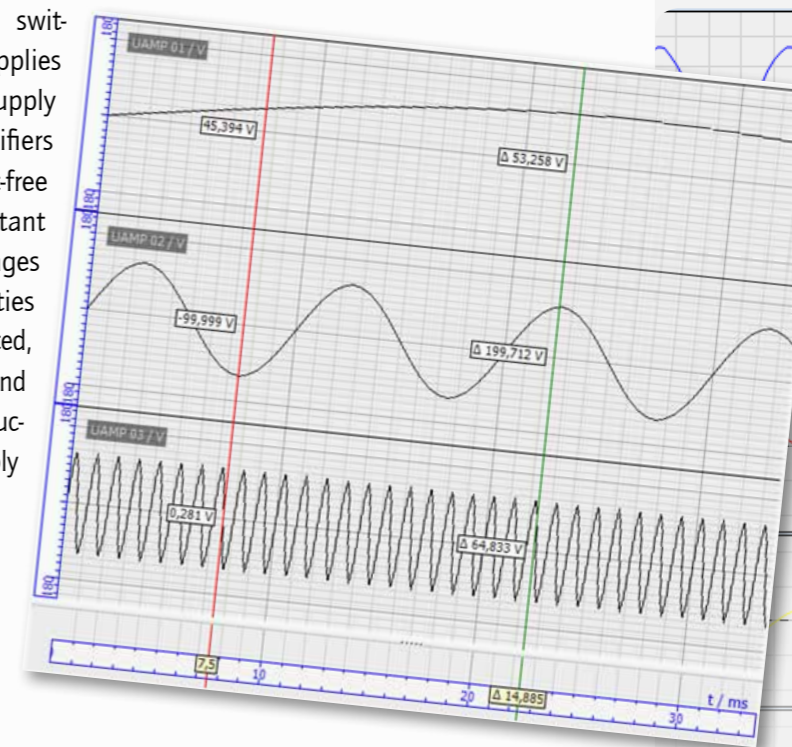

Equipment and handling

ARTES 460|600 test systems are compact, universal solutions for testing all types of protection relays. The built-in control panel, light weight and low noise level make these robust test systems equally suitable for use on site and in the lab.

Stand-alone operation with touch screen

ARTES 460|600 test instruments can be operated and controlled with the aid of a PC and the ARTES testing software or with the built-in control panel. The control panel features a high-resolution, resistive 3.5" or 5" touch screen, function keys and a jog wheel.

The clearly structured user interface guides the user quickly and intuitively through the process required to complete the task in hand. The test instrument reacts directly to user actions, all processes run smoothly and without delay.

Settings can be made quickly with the ergonomic jog wheel.

The illuminated ring integrated in the wheel clearly displays the test status; acoustic signals are an additional source of information and also provide feedback when settings are made as well as during tests.

The USB, Ethernet and Wi-Fi (ARTES 600) interfaces allow direct connection to PCs or any network.

LEDs for status indication

LEDs on the front panel indicate the states and operating modes of the inputs and outputs. The user can tell at a glance which outputs are active and can easily identify the states of the binary inputs and outputs.

Multi-function inputs

The ARTES 600 features 12 multi-function inputs in 6 galvanically separated groups. These inputs can be used for analog quantities as well as for dry or wet binary signals. For the purposes of evaluation, the response threshold and the response range can be configured freely for the individual groups. In addition to the multi-function inputs, ARTES 600 also features two analog inputs for the 0...±20 mA measuring range.

Analog and binary measurement inputs

The ARTES 460 has eight binary inputs which are protected against polarity reversal and are configurable for measuring dry or wet contacts.

In addition to the binary measurement inputs, there are also eight analog inputs with a switchable measuring range.

Output of control commands via binary outputs

ARTES 460|600 test systems can address the protection device under test with binary signals as well as with analog measurement quantities. These binary signals are generated simultaneously with the analog quantities and can be used as control commands for the protection device during the test procedure.

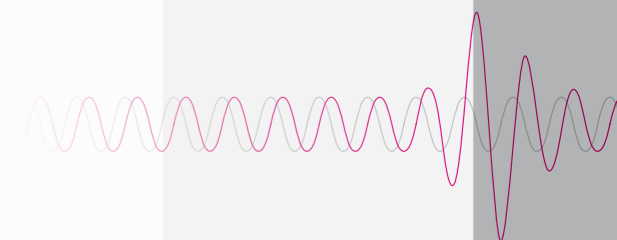
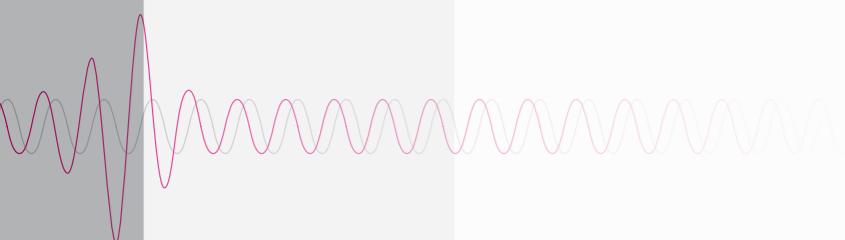
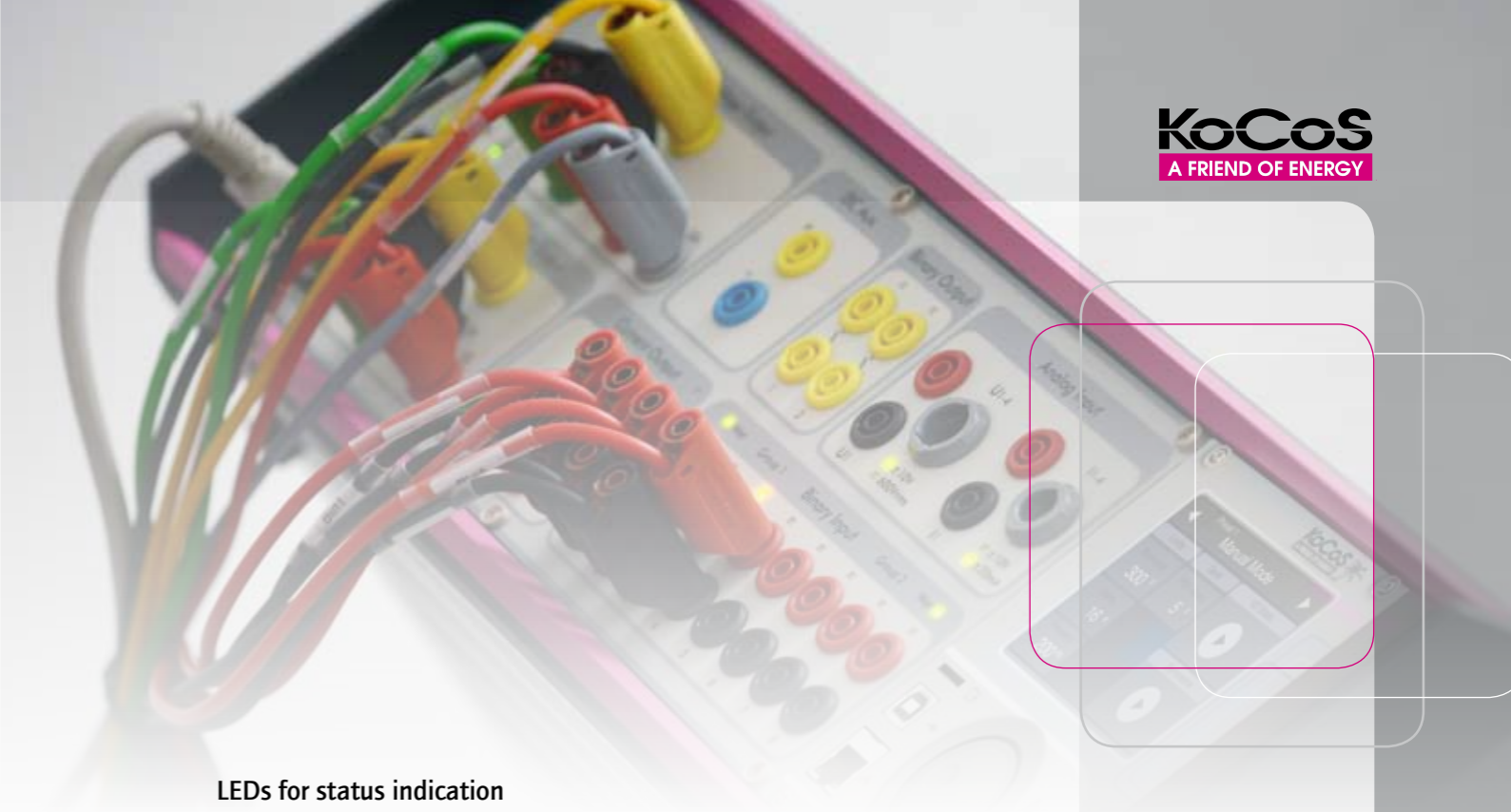
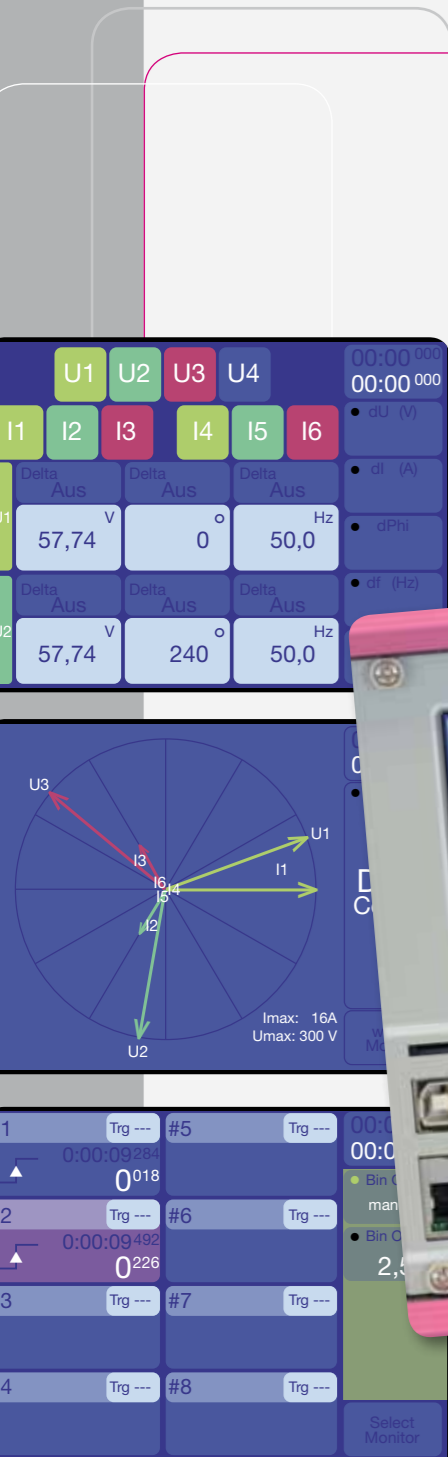

DC Aux.

+

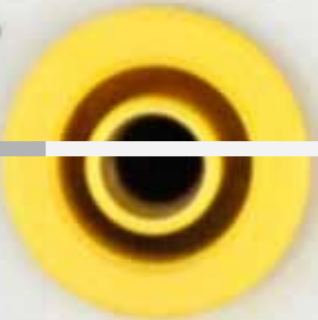

-

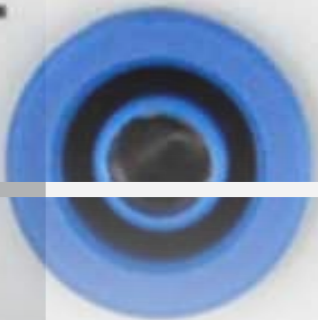

Testing protection devices with low-level signal inputs

Special low-level outputs with very high accuracy make it possible to test protection devices with low-level signal inputs. All signals can be set separately and independently of one another as regards phase, amplitude and frequency. This makes it possible to reproduce the behaviour of various different sensors, such as Rogowski coils, precisely. All outputs also have overload and short-circuit protection.

Separate auxiliary power supply

ARTES 460|600 test systems have a separate auxiliary power supply as standard equipment. The auxiliary voltage can be used to supply the test object, for example. The range is between 12...260 VDC.

Operation in a vertical position

All the connections required for linking up to the device under test can be found on the front panel where they are arranged ergonomically and are easily accessible. The power supply and the external interfaces are also located on the front panel. ARTES 460|600 test devices can be stood upright on the floor if necessary and still be operated comfortably.



Can be used all over the world

The voltage and frequency range of the integrated wide-range power supply units provide a high degree of flexibility for powering ARTES 460|600 test instruments, allowing them to be connected to any national supply voltage or to DC station batteries.

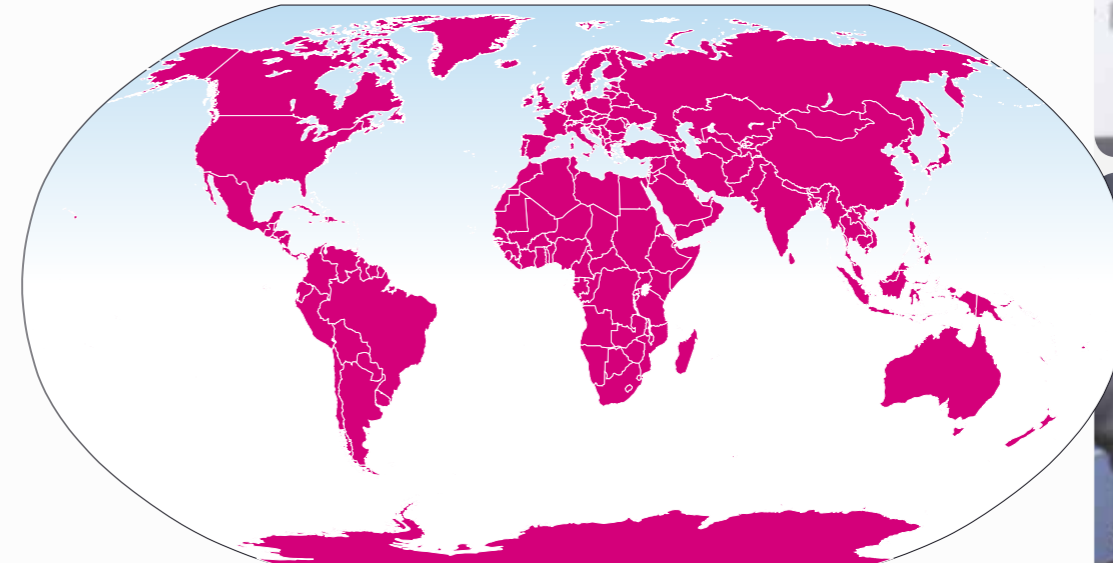

ARTES
ARTES

Software-controlled device calibration

ARTES 460|600 test instruments have been specially designed to enable users to carry out the calibration themselves. This eliminates periods of unavailability while the test instrument is sent away and also does not involve any costs. Calibration is controlled by the software. There is no need to open the device and make adjustments using potentiometers.



THE ARTES TESTING SOFTWARE

Featuring a Microsoft Fluent user interface and an amazing range of functions, the new ARTES relay testing software really breaks new ground. Once again, KoCoS is at the cutting edge of the development of Windows-based testing software.

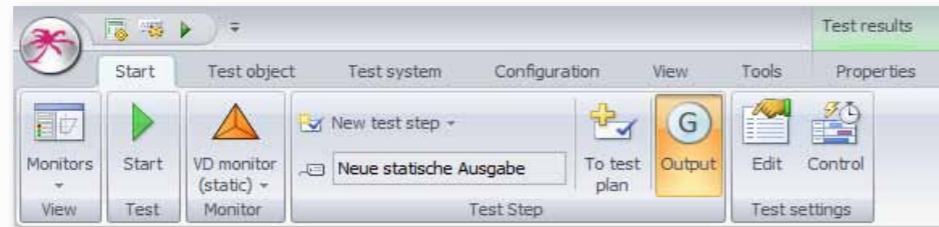

The restructured Microsoft Fluent user interface provides a wide range of new functions.

The Fluent interface makes working with the ARTES testing software both faster and more efficient. Traditional menus and toolbars have been replaced by a ribbon. The advantages of this user interface include improved handling and significant savings in time due to the use of context-specific tabs and the ease with which new users become familiar with the software.

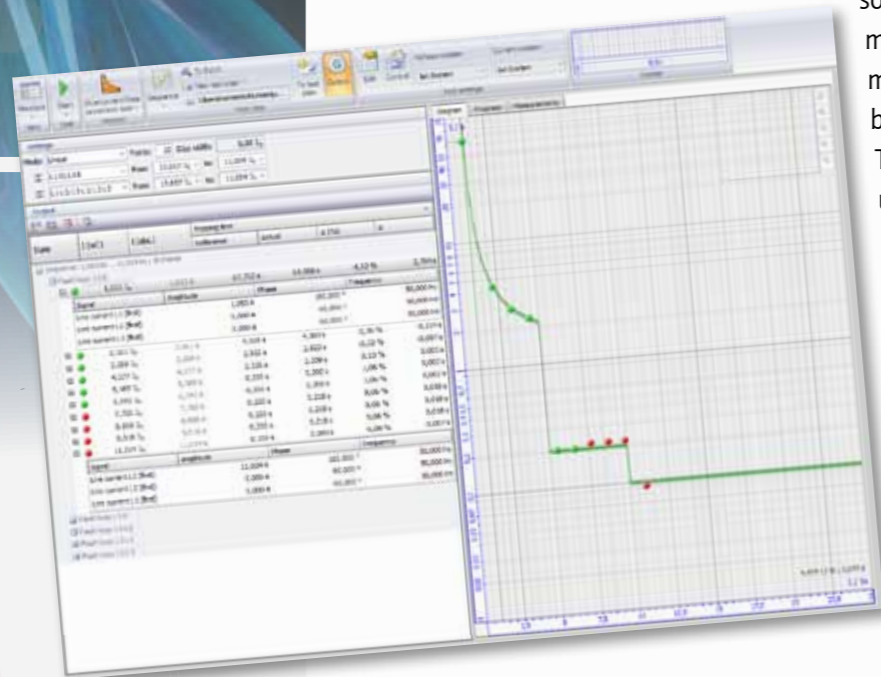

Clearly structured asset management based on the test object

Another noteworthy feature of the software is its asset management. The global definition of protection functions as well as the derivation and inheritance of properties from a wide variety of different type templates are what make this feature so special. In addition, it is possible to edit specific individual relay settings and test instructions as well as to make global settings for instrument transformers, earthing and the direction of the rotating field.

The asset management also allows the integration and management of external documents. This means that any information which may be required is always immediately available.

Graphical display of connection schemes

A graphical display of connection schemes can also be found in the ARTES testing software. This makes it easier to connect the device under test and goes a long way towards ruling out mistakes.

Pre-defined models are available for the various protection functions and can be selected directly, making configuration much simpler.

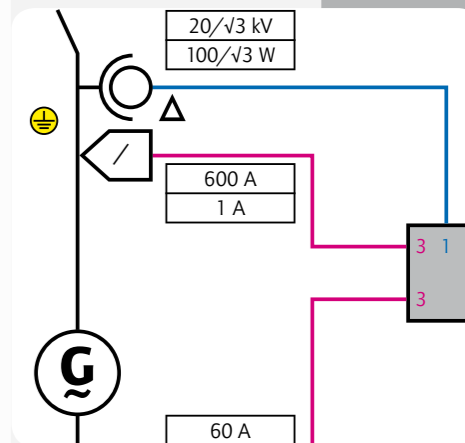
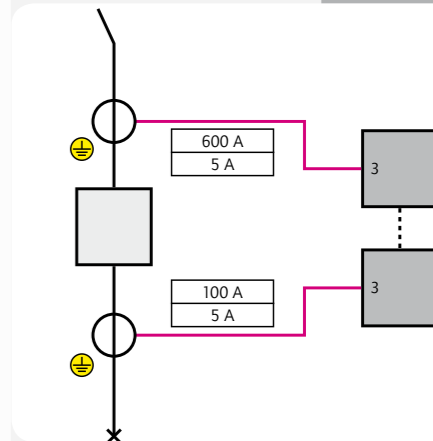
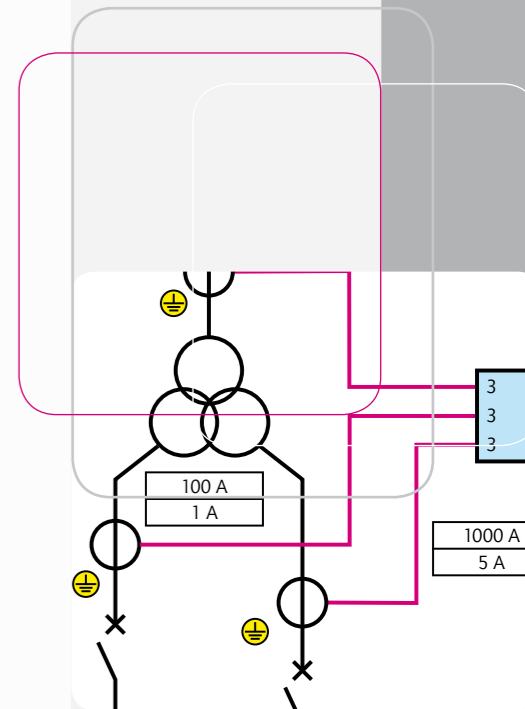
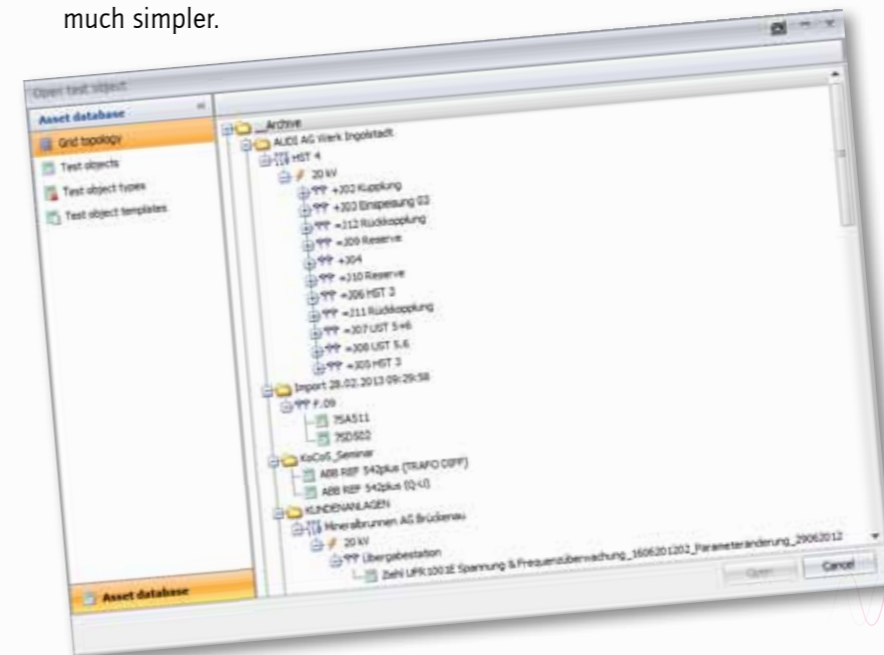

Individual test plans

An individual test plan can be created easily for each device under test. Individual tests can be combined to form complete device or type tests. These test plans can then be repeated any number of times under identical test conditions, making it possible to automate entire test procedures.

Display and evaluation of measurement results

During tests, the progress of the analog input quantities and the status signals and commands of the device under test captured by ARTES are displayed in real time with correct timing relative to one another. This information is displayed both graphically and numerically. Tests can be closely monitored and assessed while still in progress.

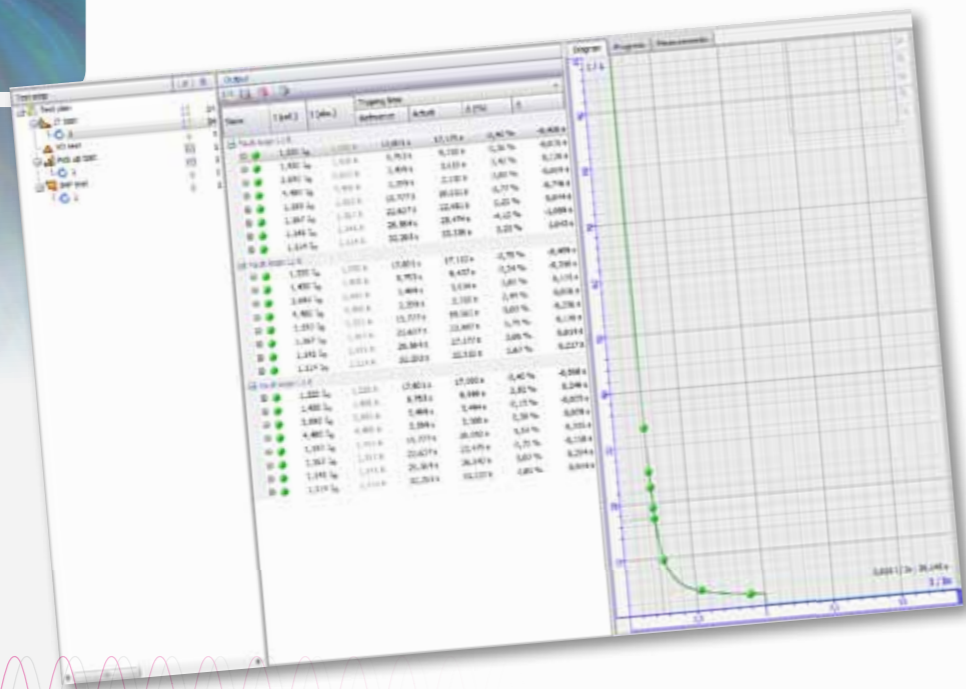

The reaction of the device under test is evaluated automatically by the programme during the course of the test. For each test point, an online indicator shows whether or not the result lies within the configured tolerance range.

All the results are displayed clearly in a table immediately after the test. Each line contains the information on an individual test point.

The list of results can also be presented in the form of a test report. This report is generated automatically by the programme and contains all the relevant data, parameters and test results. The structure and the layout of test reports can be tailored in accordance with individual requirements and preferences.



ARTES test monitors

Generally speaking, the VD-Monitor included in the scope of delivery is capable of meeting all test requirements.

The ARTES software also offers a range of convenient test monitors which have been specially developed for testing different protection functions. These test monitors simplify, automate and significantly speed up tests for a range of different types of relays.

VD-Monitor

The VD-Monitor enables the user to test any protection function by setting the test quantities manually. As well as entering secondary values, primary values can also be used to define all settings. Time-consuming manual conversion of the quantities is a thing of the past.

The output signals of the current and voltage amplifiers are set entirely independently from one another as regards amplitude, phase and frequency and are varied independently from one another during tests. In addition, the output signals of certain or all amplifier outputs can also be ramp ascending or descending within the configured range.

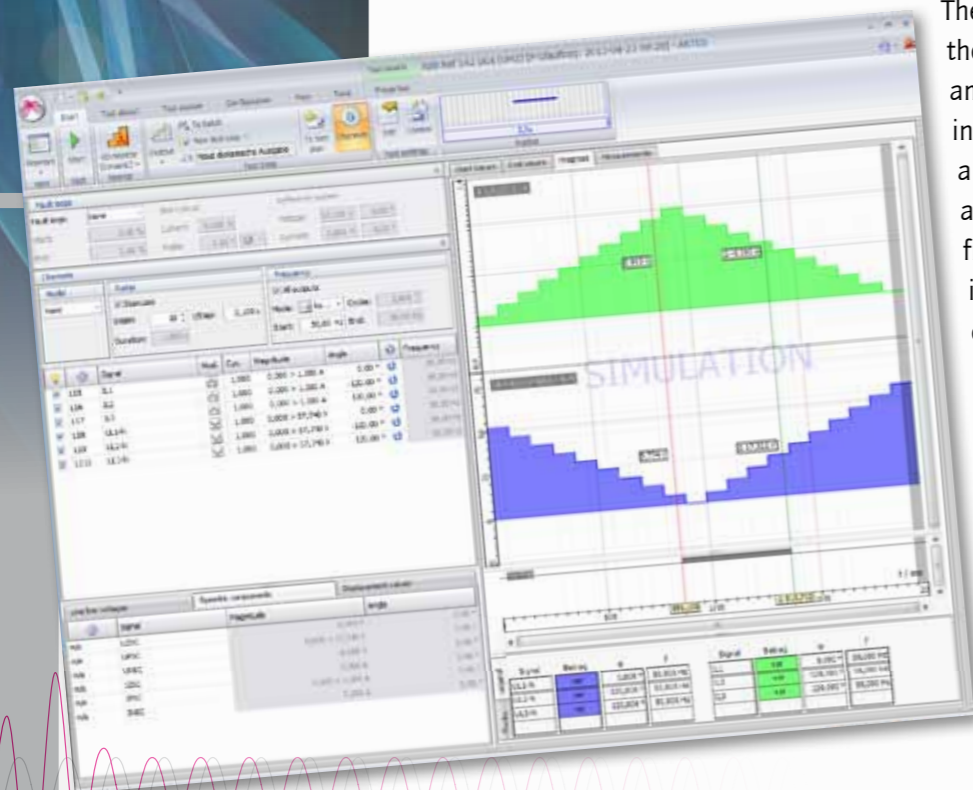

Presetting fault loops

Selecting a fault loop facilitates the reproduction of a specific fault. The parameters of the individual channels, which can be modified for the selected fault, are pre-defined automatically. This means that it is possible to test a two-pole fault taking the phase-correct behaviour of the faulted quantities into account.

Fault definition with symmetrical components

It is also possible to define the test quantities by entering the symmetrical components directly. The output quantities are calculated automatically by the software. Unsymmetrical systems, caused by earth faults, for example, can be defined directly with speed and efficiency.

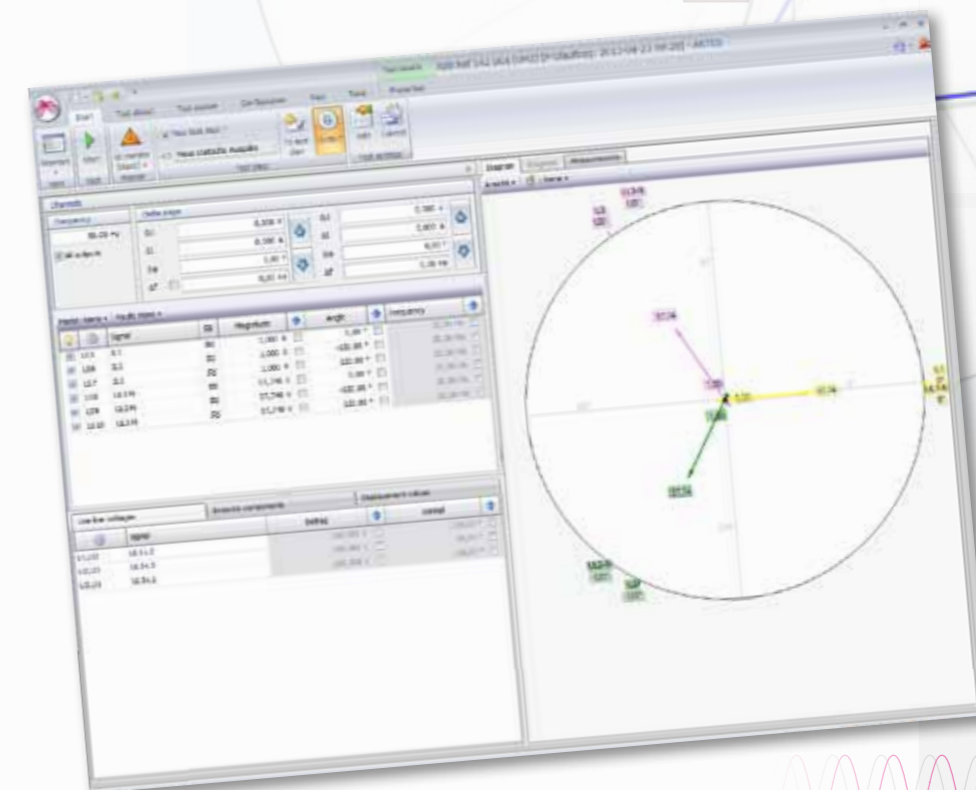

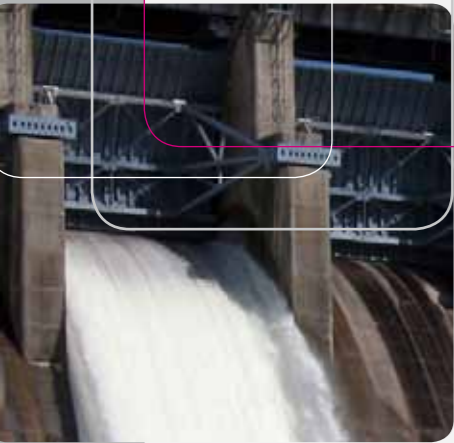

IT-Monitor

The IT-Monitor can be used to check the operating times and directional sensitivity of overcurrent relays with current-dependent and current-independent time delays. The programme automatically calculates the test quantities for the defined test current and selected fault type. The amplitude of the test current is defined in the current-time diagram. Test evaluation is performed with reference to the defined tripping characteristic which can be freely configured in the programme. In addition, the programme already contains all standard characteristics according to IEC and ANSI. The IT-Monitor also features a function for checking the directional control. In this case the relay is supplied with the relevant voltages as well as the currents.

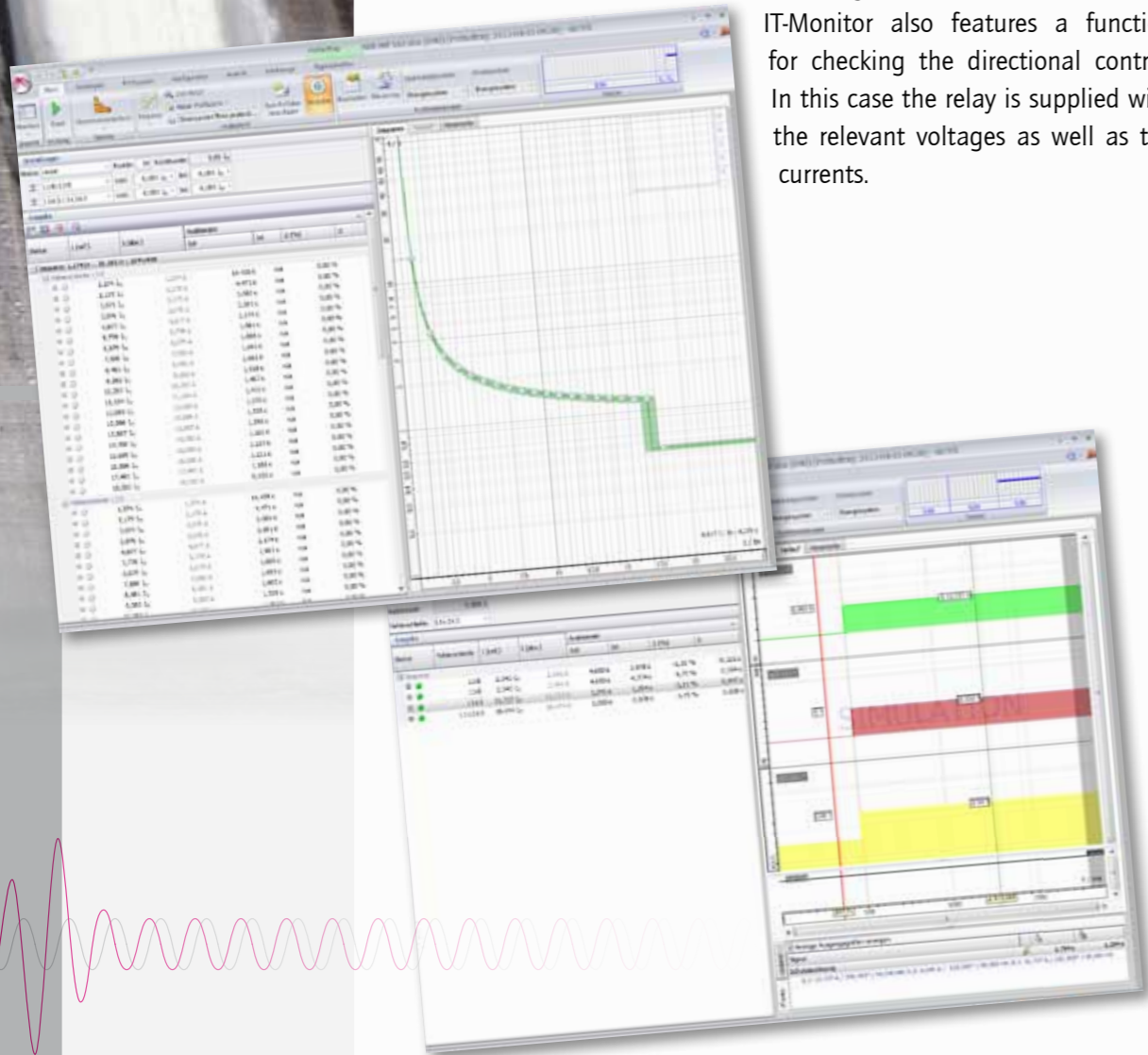

IMP-Monitor

The IMP-Monitor can be used to check the operating times and impedance zones of distance protection devices. The programme automatically calculates the test values for the defined fault impedances and the selected fault type. The required fault impedance is defined in the complex impedance plane or in the distance-time diagram. In addition, the IMP-Monitor enables the ARC (Auto-Restore) function of the protective equipment to be checked. The aim of this test is to verify the dead times of a successful or unsuccessful auto-restore operation.

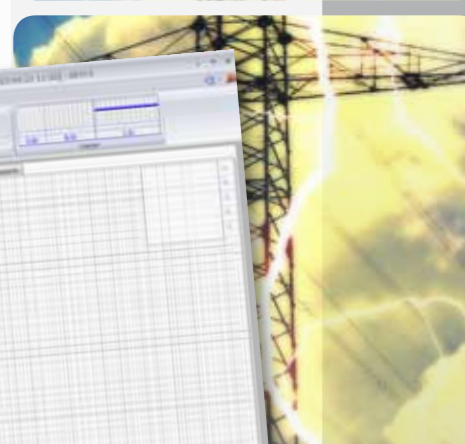
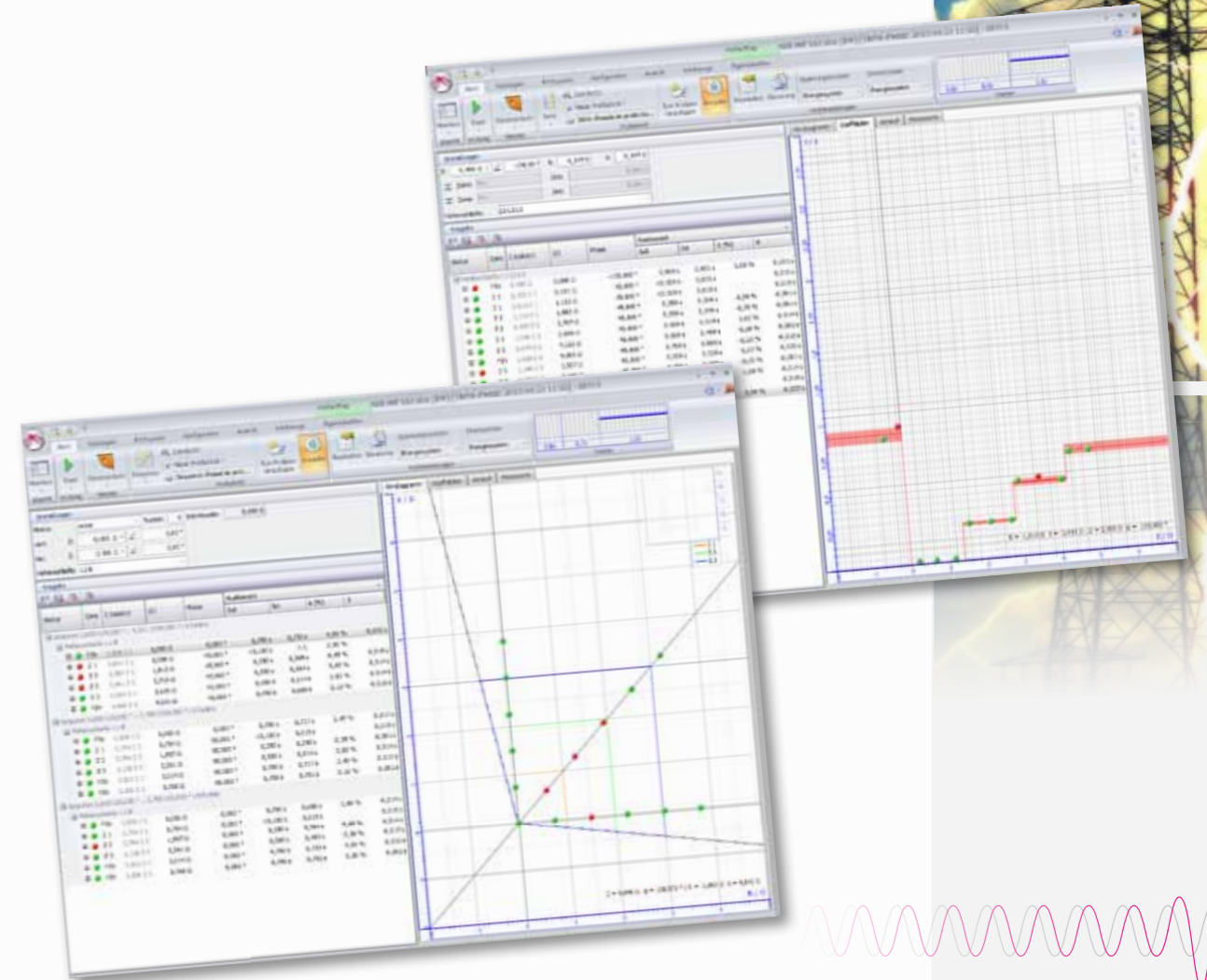

TRANSIG-Monitor

The TRANSIG-Monitor can be used to check the correct functioning of the device under test in real conditions.

The monitor can be used for the full graphical display and output of recorded signal characteristics which are available in standard COMTRADE format and can come from fault recording systems or digital protection relays. During tests these signal characteristics are „played back“ by the test instrument as transient signal waveforms.

The TRANSIG-Monitor also includes a signal editor which can be used to configure and calculate any signal characteristic. The signal characteristics can be generated from a basic function, such as a sine wave, with one or more superimposed functions, such as a direct component, exponential functions, harmonics, etc.

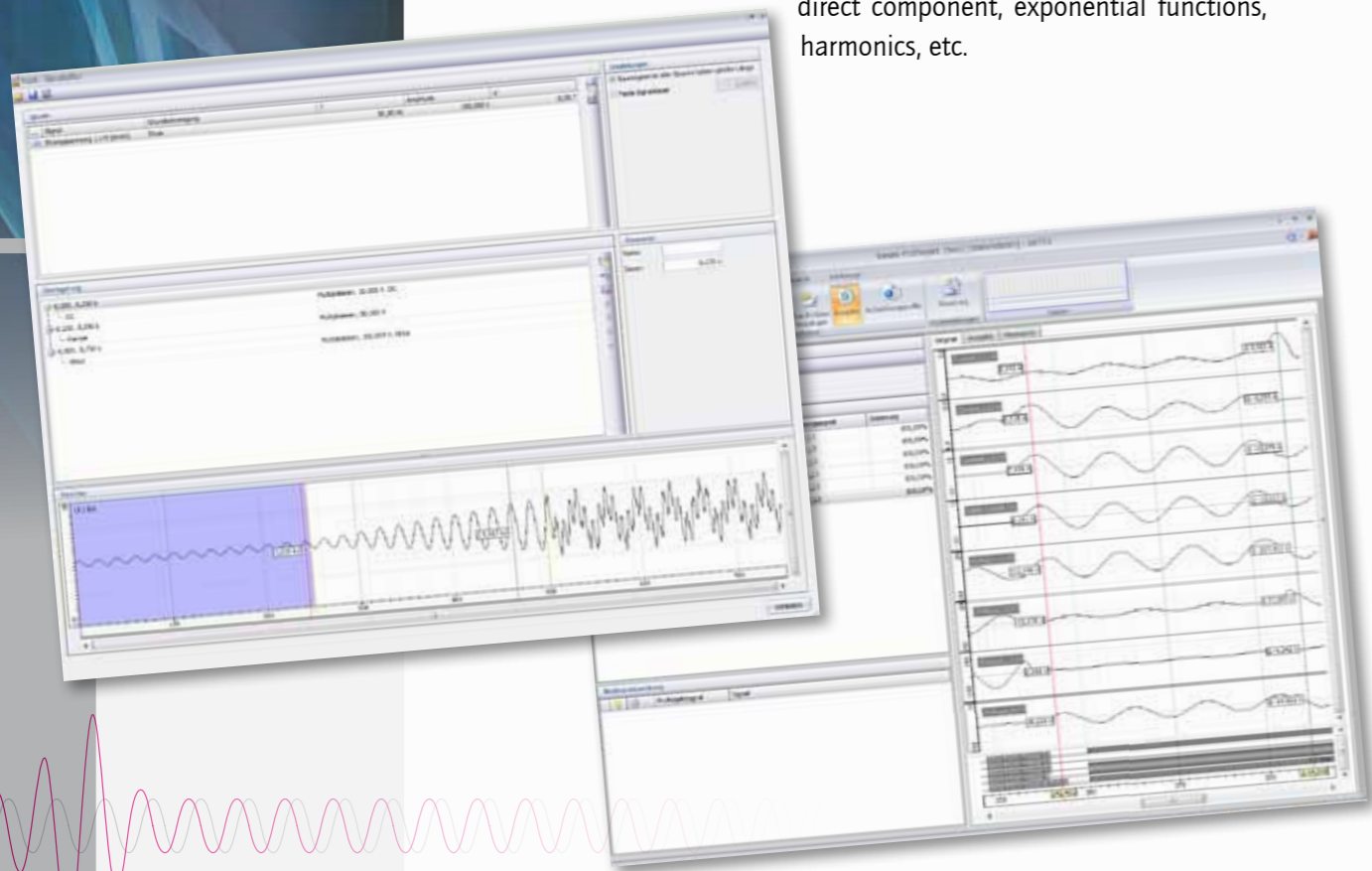

SYNC-Monitor

The SYNC-Monitor can be used to test paralleling devices and synchronizers which use frequency and voltage adjusters.

The systems to be synchronised are represented by voltages of the test instrument during the test. The amplitude and the frequency of the test quantities can be changed manually or via the control commands of the synchronizer. The test quantities and the voltage, frequency and phase difference between the voltage to be synchronised and the reference voltage are displayed numerically in real time in the SYNC-Monitor display during the test. The phase difference is also displayed graphically in the synchroscope.

The measurement values are automatically evaluated immediately after a test. A table displays the test quantities at test begin, at the time of the switching command and at the point in time at which the circuit breaker closed, taking the operating (closing) time of the circuit breaker into account.

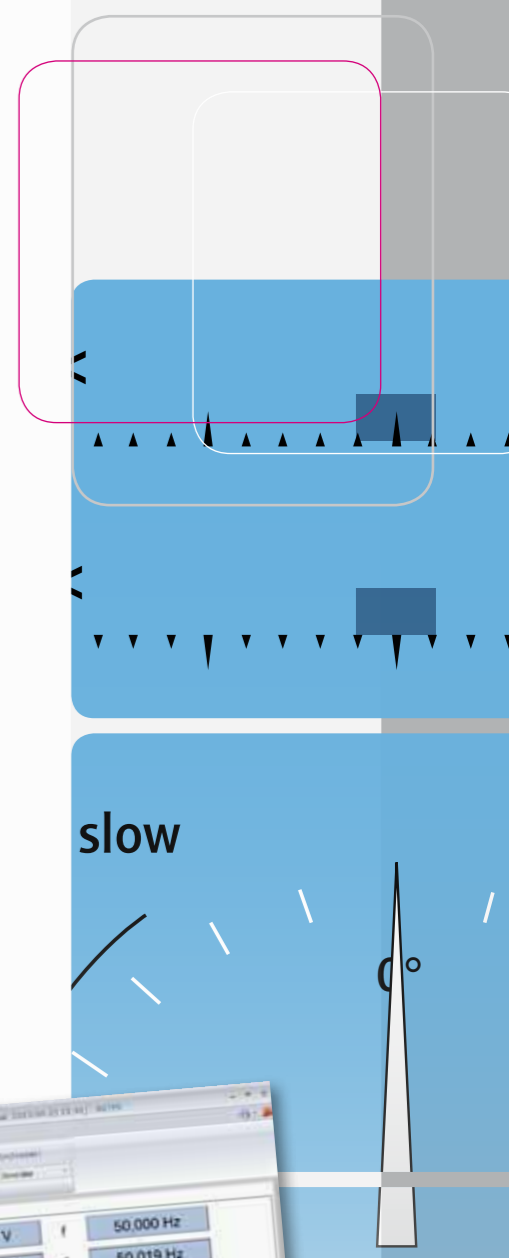



DIFF-Monitor

The DIFF-Monitor enables the tripping characteristic and operating times of differential protection relays to be checked. Test values are calculated automatically with reference to the nominal data of the transformer and the HV/LV data. With transformers using phase-rotation vector groups, for example YD 5, the programme performs a phase adjustment between the currents of the high-voltage and low-voltage side which are to be compared. In addition to the vector group adjustment, an amplitude adjustment is also performed. Tests are evaluated with reference to the stabilization characteristic of the differential protection device.

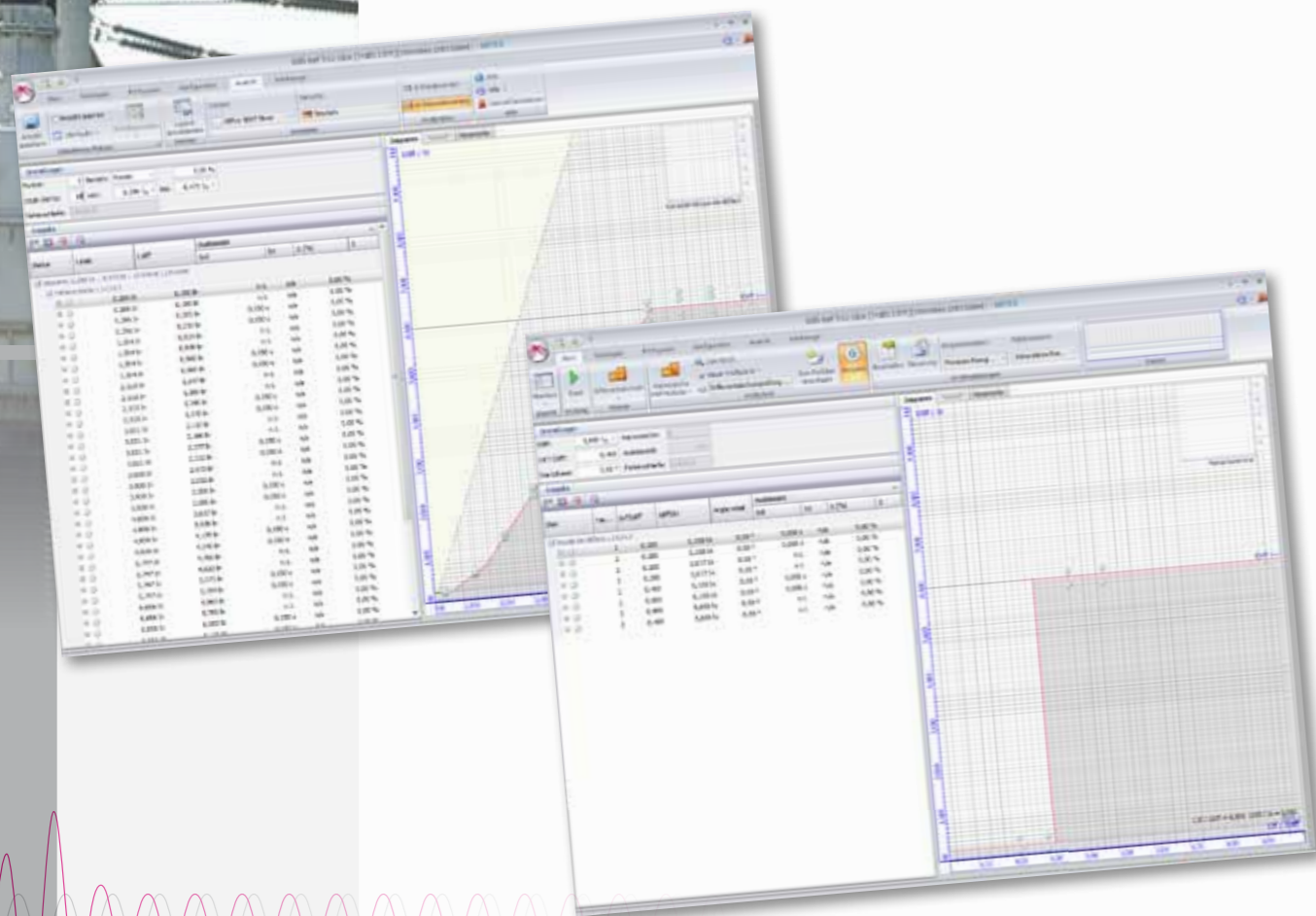

TD-Monitor

The TD-Monitor provides an easy way to test transducers. In addition to current, voltage, frequency and phase transducers, it is also possible to test active power, reactive power and apparent power transducers and devices used for measuring the power factor or reactive power factor. The output quantity of the transducer is recorded during the test via the analog inputs of the ARTES device. In the TD-Monitor, the test quantities and the output signal of the transducer are displayed numerically in real time during tests. In addition, the absolute error, the relative error and the full scale error are calculated and displayed both numerically and graphically.

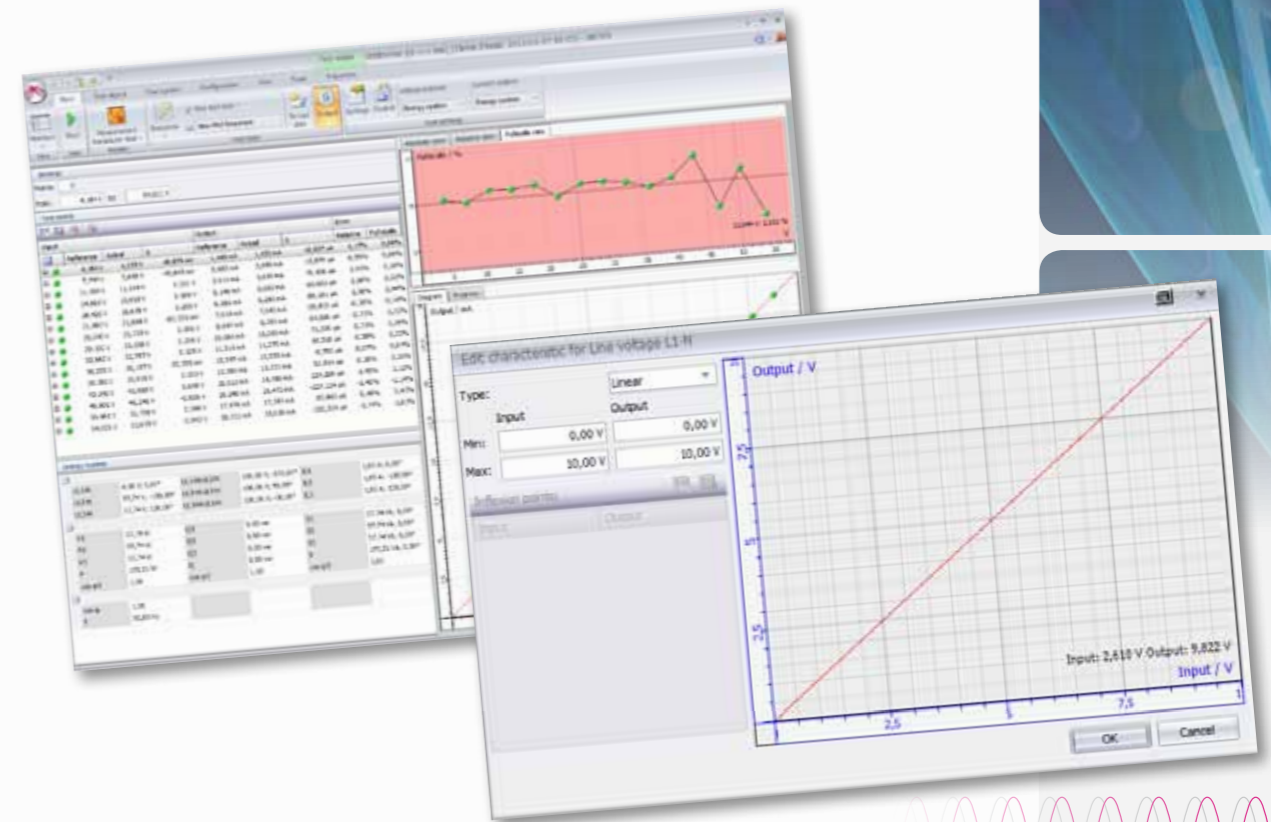

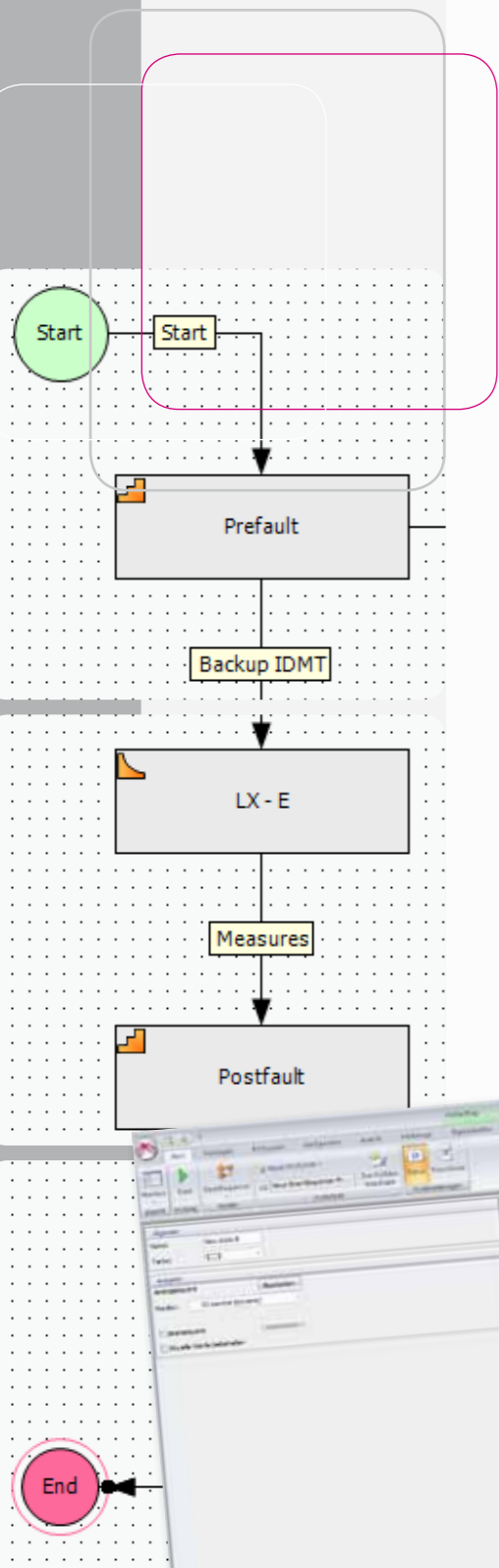

SmartSequencer

The SmartSequencer can be used to create any kind of test procedure. A test procedure is similar to a test sequence in the VD-Monitor, which can consist of a number of static and dynamic signal characteristics.

However, in the VD-Monitor the individual characteristics (also termed states) have a fixed, pre-defined length and are run sequentially one after the other.

Using the SmartSequencer it is possible to "run" these states in an event-controlled manner. A different progression condition (transition) can be defined for each state. This might be the reaction of the device under test in the form of a binary signal or alternatively a defined time, for example.

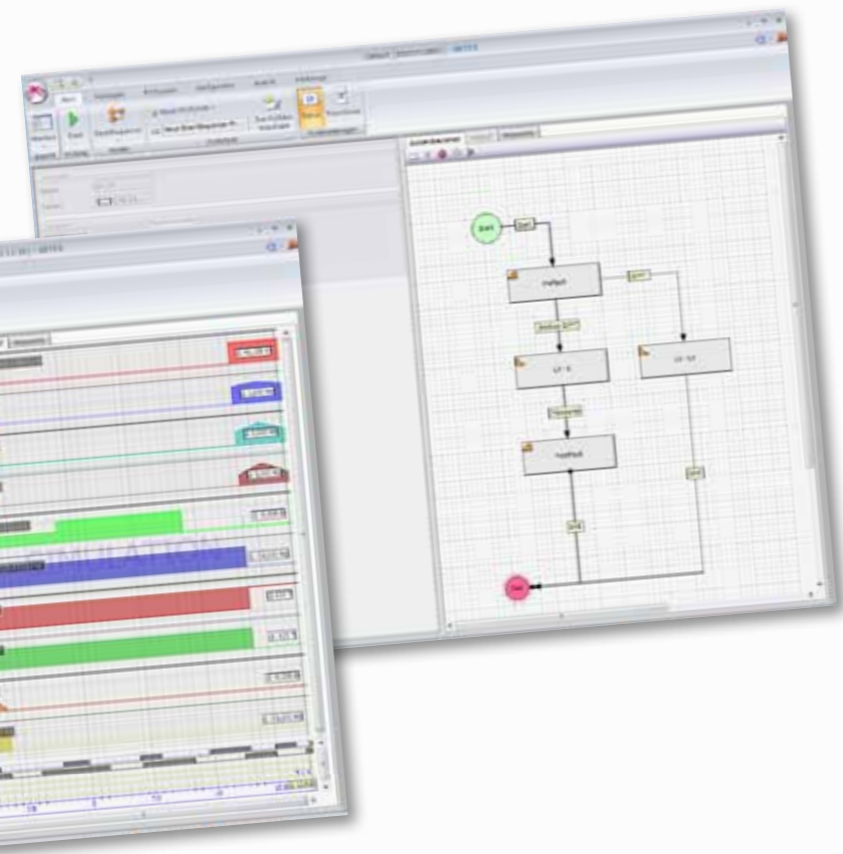

PIC-Monitor

The PIC-Monitor can be used to determine the pick-up and drop-off values of protection relays.

This could also be the pick-up value of the second instantaneous tripping set (high set) of an overcurrent relay, for example. The test quantities are issued as stair-step pulsed ramps for this purpose. The amplitudes are increased until the pick-up value is reached. To ascertain the drop-off value, ARTES then automatically switches to a stair-step descending ramp.

The programme calculates the test quantities fully automatically with reference to the start and end values set for the ramps and to the fault loop which has been selected. The reaction of the device under test is recorded in real time during the test and subsequently evaluated.

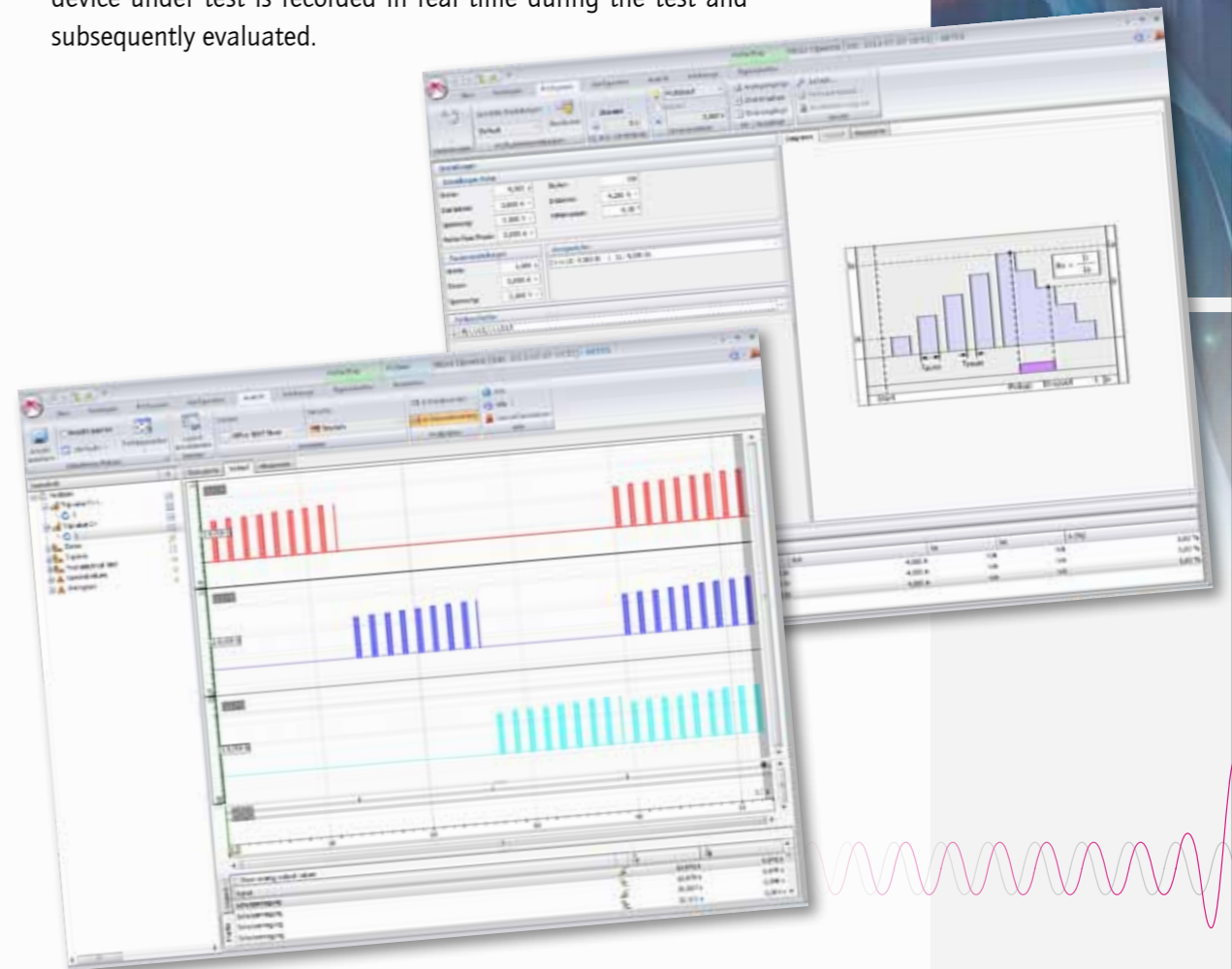



QU-Monitor

Using the QU-Monitor, the Q-U protection function can be tested fully automatically. The QU-Monitor supports various different response characteristics for the Q-U protection function implemented by the manufacturers of protection devices.

As well as verifying the tripping characteristic, it is also possible to check the pick-up and drop-off values of the protection relay for the undervoltage threshold, the minimum current, the minimum reactive power and the angle range of the reactive power direction. Selecting a fault loop makes it possible to reproduce phase-selective fault types as well. This allows the undervoltage threshold and the function of the logical AND-link to be checked in one test step.

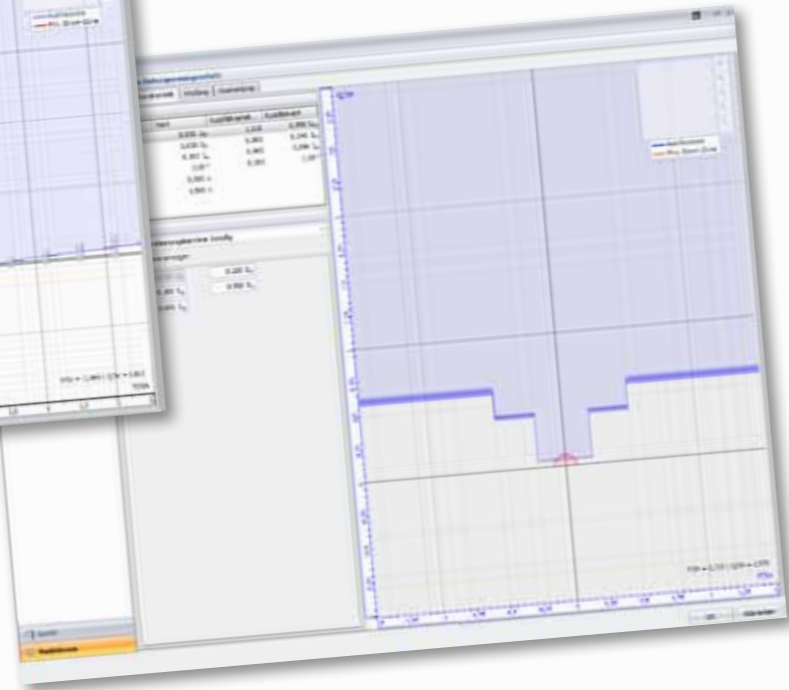

Overview of test monitors (included in the scope of delivery)

Monitor	Test function
VD	Test any protection function by setting the test quantities manually
IT	Check the operating times and directional sensitivity of over-current relays
IMP	Check the operating times and impedance zones of distance protection devices
TRANSIG	Display and output COMTRADE records and generate any signal characteristic
SYNC	Test paralleling devices and synchronizers
DIFF	Check the tripping characteristic and operating times of differential protection relays
TD	Determine measuring transducer error
SmartSequencer	Event-controlled output of test sequences
PIC	Determine the pick-up and drop-off values of protection relays
QU	Check the Q-U protection function

Software modules and packages

Software module IEC 61850
Software module for the integration of the test systems in an IEC 61850-8-1 communication environment. Pick-up and trip messages are received and evaluated via GOOSE telegrams.

OPTIONS & ACCESSORIES

Device options

Internal GPS receiver for time synchronization

Internal GPS receiver module for precise time synchronization. An active GPS antenna with magnetic base, 2 m antenna lead and 10 m antenna extension cord are included in the scope of delivery.



Cable sets

Standard cable set SCS 460 | 560 | 600

Connecting leads for 4 voltage outputs, 6 current outputs and 4 binary inputs, 20 terminal adapters with insulated 2.5 mm² round Cu-wire for connecting into rail-mounted terminals and 20 plug adapters for connecting safety measuring leads to conventional 4 mm sockets.



Connection cable LCC for 4 low-level signal outputs or 4 current measurement inputs

Connection cable for one low-level signal socket. With ARTES 460|560|600, this cable can be used to make a connection between one of the three low-level signal connection sockets and the device under test. With ARTES 460|560, the connection cable can also be used to feed up to four signals to the current measurement inputs. One end has a coded push-pull plug for connection to the test instrument, the other end has 4 mm safety plugs for connection to the test object, length 2 m.



Connection cable VCC for 4 voltage measurement inputs

The VCC connection cable can be used to feed up to 4 signals to the voltage measurement inputs of ARTES 460|560 test instruments. The cable is 2 m long. One end of the cable is fitted with a coded push-pull plug for connection to the test instrument; the other end of the cable is fitted with 4 mm safety plugs for connection to the device under test.



Generator connection cable OCC 33

Connection cable for the generator socket of ARTES 600. The cable allows three voltages and three currents to be tapped. One end has a generator connection plug for connection to the test instrument; the other end has 4 mm safety plugs for connection to the test object, length 2 m.





Adapters

Plug adapters PA, 25 pieces

Adapter for connecting measuring leads with 4 mm safety plugs to conventional 4 mm sockets.



Terminal adapters, 25 pieces

Adapter for connecting measuring leads with 4 mm safety plugs to rail-mounted terminals. The adapter converts a 4 mm safety plug to 2.5 mm² round Cu-wire.



Wrap-around bags and carrying cases

Wrap-around bag for ARTES 460 | 560

Robustly made, lightly padded wrap-around bag with shoulder strap. The bag is fitted with reinforced panels for dimensional stability and features separate compartments for accessories.

Wrap-around bag for ARTES 600

Robustly made, lightly padded wrap-around bag with shoulder strap. The bag is fitted with reinforced panels for dimensional stability and features separate compartments for accessories.



**Carrying case RCS 160 for
ARTES 460 | 560**

Carrying case made of ABS plastic shells with anodised aluminium rim. Easy manoeuvrability is provided by the retractable handle and wheels. The case is lockable and is delivered complete with a rigid foam insert to snugly fit the device inside.

External dimensions : 600 x 510 x 300 mm
Weight: 6.5 kg



**Carrying case RCS 960 for
ARTES 600**

Extremely robust, water- and dust-proof carrying case. Easy manoeuvrability is provided by the retractable handle and wheels, two holes for padlocks. The case is delivered complete with a rigid foam insert to snugly fit the device.

External dimensions: 645 x 508 x 368 mm
Weight: 8.7 kg



**TRAINING COURSES &
SEMINARS**

Know-how based on experience

The construction and smooth operation of protection systems is a task which is becoming increasingly complex all the time, so there is a very real need for specialist training courses and seminars.

Regular product training courses are held at our training centres in Korbach and Weimar, as well as on our customers' premises. Special hands-on seminars and workshops which deal primarily with application-related themes round off our training portfolio. Our training centres are well equipped with the latest measuring and test equipment for hands-on exercises.

